

ACDCTM

DYNAMICS
www.acdc.co.za

The Leading Supplier of Industrial & Commercial

TOOLS & TEST INSTRUMENTS

Installations have never been so easy!



THINK ELECTRICAL



DIGITAL MULTIMETERS









Code	MS320	MAS830	MS8321D	MS8233E	MS8301D	MY60
Features	<ul style="list-style-type: none"> • Pocket size • LCD display • Auto ranging • Data hold • Auto power Off • Cat II 600V • Cat III 300V 	<ul style="list-style-type: none"> • Pocket size • LCD display • Data hold • Cat II 600V • Cat III 600V 	<ul style="list-style-type: none"> • Large LCD display • Data hold • Transistor tester • Auto Power Off • Cat II 1000V • Cat III 600V 	<ul style="list-style-type: none"> • Non contact voltage detector • Back lit LCD display • Auto ranging • Max/Data hold • °C/°F (-20-1000°C) • Auto Power Off • Cat III 600V 	<ul style="list-style-type: none"> • New smart auto testing meter auto detects type of test & range. • Backlit LCD display • Auto Power off • Dual display • Max/Min/Data Hold • Non Contact Voltage • Cat III 600V 	<ul style="list-style-type: none"> • Large LCD display • Data hold • Transistor tester • Auto power off • °C/°F (-20-1000°C) • Cat II 1000V • Cat III 600V
Ranges:						
AC Voltage	4V - 600V	200V & 600V	2V - 750V	2V - 600V	6V - 600V	2V - 750V
DC Voltage	400mV - 600V	200mV - 600V	200mV - 1000V	200mV - 600V	6V - 600V	200mV - 1000V
Diode Test	Yes	Yes	Yes	Yes	—	Yes
AC Current	40mA - 400mA	—	2mA - 20A	200µA - 10A	—	2mA - 10A
DC Current	40mA - 400mA	200µA - 10A	200µA - 20A	200µA - 10A	—	2mA - 10A
Resistance	400Ω - 40MΩ	200Ω - 2MΩ	200Ω - 20MΩ	200Ω - 20MΩ	2kΩ - 10MΩ	200Ω - 200MΩ
Capacitance	4nF - 100µF	—	—	—	—	—
Frequency	0 - 100KHz	—	—	—	60Hz - 3kHz	—
Continuity	Yes	Yes	Yes	Yes	Yes	Yes







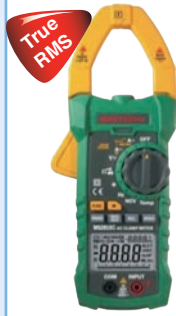

Code	MS8264	MS8250A	MS8253D	MS8340B	MS8228	MS8050
Features	<ul style="list-style-type: none"> • Backlit LCD display • Data hold • Transistor tester • Auto Power Off • °C/°F • Cat II 1000V • Cat III 600V 	<ul style="list-style-type: none"> • Non contact voltage detector • Backlit LCD display • Relative measurement • Auto ranging • Data hold • Auto power off • Duty Cycle • Cat IV 600V 	<ul style="list-style-type: none"> • Non-Contact Voltage Detector • USB interface (Windows) • Backlit LCD Dual display • Relative Measurement • Auto Ranging • Max/Min/Data Hold • Auto power off • Duty Cycle • Cat IV 600V 	<ul style="list-style-type: none"> • USB interface (Windows) • Peak measurement • Backlit LCD display • Bargraph display • Auto ranging • Auto power off • Max/Min/Data hold • Relative measurement • Duty Cycle • Cat III 1000V 	<ul style="list-style-type: none"> • Relative humidity • Infrared/environmental thermometer • Backlit LCD Dual display • Auto ranging • Auto power off • Transistor tester • Data hold • Duty Cycle • Relative Measurement • Cat II 1000V • Cat III 600V 	<ul style="list-style-type: none"> • VFD Display • PC Analysis Software • DataLogging: 30 Groups • USB interface (Windows) • Max/Min/Data Hold • Auto Ranging • Auto power off • Relative Measurement • Power Sup.: 110/220VAC • Cat II 1000V
Ranges:						
AC Voltage	2V - 750V	400mV - 600V	660mV-1000V	2.2V - 700V	40mV - 750V	50mV-1000V
DC Voltage	200mV - 1000V	400mV - 600V	660mV-1000V	220mV - 1000V	40mV - 1000V	50mV-1000V
Diode Test	Yes	Yes	Yes	Yes	Yes	Yes
AC Current	2mA - 10A	400µA - 10A	660µA-10A	220µA - 10A	400µA - 10A	500µA-10A
DC Current	2mA - 10A	400µA - 10A	660µA-10A	220µA - 10A	400µA - 10A	500µA-5A/10A
Resistance	200Ω - 200MΩ	400Ω - 40MΩ	660Ω-66MΩ	220Ω - 220MΩ	400Ω - 40MΩ	500Ω-50mΩ
Capacitance	20nF - 20µF	50nF - 100µF	6.6nF-66mF	22nF - 220mF	50nF - 100µF	50nF-5000µF
Frequency	0 - 20KHz	0 - 5MHz	0-66MHz	0 - 220kHz	10Hz-100KHz	5Hz-2MHz / 5Hz-200kHz
Temperature	-20-1000°C	-	-	-	0 - 40°C / -20 - 300°C (IR)	-
Continuity	Yes	Yes	Yes	Yes	Yes	Yes

TEST INSTRUMENTS, TOOLS & GENSETS

DIGITAL CLAMP METERS

							
Code	M266	MS2600	MS2033A	MS2000G	MS2026R	MS2015C	MS2102
Features	<ul style="list-style-type: none"> LCD display Data hold Jaw Size: 50mm Cat II 1000V Cat III 600V 	<ul style="list-style-type: none"> Large backlit LCD display AutoRanging Max/Min/Data hold Auto Power Off Relative Measurement Jaw Size: 12mm Cat III 600V 	<ul style="list-style-type: none"> New smart auto Testing. Meter auto detects type of test and range. Backlit LCD display Dual display Max/Min/Auto Data hold Jaw size: 26mm Cat III 600V 	<ul style="list-style-type: none"> Backlit LCD display Data hold Jaw Size: 55mm Cat II 1000V 	<ul style="list-style-type: none"> Backlit LCD display Max/Min/Data hold AutoRanging Auto Power Off Duty Cycle Work light (torch) Jaw Size: 40mm Cat III 600V 	<ul style="list-style-type: none"> Backlit LCD Dual disp. Max/Min/Data hold Auto power off/ranging Bargraph display Non contact voltage detector Duty Cycle Relative measurement Work light (Torch) Jaw Size: 40mm Cat III 1000V 	<ul style="list-style-type: none"> Large backlit LCD display Auto Ranging Auto Power Off Bargraph display Data hold Jaw Size: 28mm Cat II 600V
Ranges:							
AC Voltage	750V	4V - 700V	6V - 600V	200V - 750V	6V - 750V	6.6V - 750V	400V - 600V
DC Voltage	1000V	4V - 1000V	6V - 600V	2V - 1000V	600mV - 1000V	660mV - 1000V	400V - 600V
Diode Test	—	Yes	—	Yes	Yes	Yes	—
AC Current	20A - 1000A	200A	2A - 600A	200A - 2000A	6A - 1000A	66A - 1000A	40A - 400A
DC Current	—	—	—	—	—	—	40A - 400A
Resistance	200Ω - 20KΩ	400Ω - 40MΩ	2kΩ - 10MΩ	200Ω - 2MΩ	600Ω - 60MΩ	660Ω - 66MΩ	400Ω
Capacitance	—	40nF - 40μF	—	—	40nF - 4000μF	6.6nF - 66mF	—
Frequency	—	0 - 100kHz	60Hz - 3kHz	0 - 20KHz	0 - 10MHz	0 - 10KHz	—
Temperature	—	—	—	0°C - 750°C	—	-20°C - 1000°C	—
Continuity Test	Yes	Yes	Yes	Yes	Yes	Yes	Yes

						
Code	MS2108A	MS2108	MS2140B	MS2006B	MS2205	MS2208
Features	<ul style="list-style-type: none"> Backlit LCD display Max/Min/Data hold Auto ranging Work light (torch) Duty Cycle Jaw Size: 26mm Cat III 600V 	<ul style="list-style-type: none"> Backlit LCD display Max/Min/Data hold Auto ranging Work light (torch) 100msec inrush current measurement Duty Cycle Jaw Size: 26mm Cat III 600V 	<ul style="list-style-type: none"> Backlit LCD Dual Display Non contact voltage detector Inrush Hold Work Light Relative Measurement Duty Cycle Bargraph Display Max/Min/Data Hold Auto Ranging Auto Power Off K-Type Thermocouple Jaw Size: 40mm Cat III 600V 	<ul style="list-style-type: none"> High Sensitivity AC Leakage Large LCD display Data hold Auto Power Off Jaw Size: 31mm Cat III 600V 	<ul style="list-style-type: none"> Large backlit LCD display True RMS Auto ranging Auto Power Off Max/Min/Data hold Data logging RS232 interface (Windows OS) Jaw Size: 50mm Cat III 600V 	<ul style="list-style-type: none"> Large backlit LCD display True RMS Auto ranging Max/Min/Data hold Auto Power Off Work light (torch) Jaw Size: 26mm
Ranges:						
AC Voltage	400mV - 600V	660mV - 600V	600mV - 1000V	—	Volts: 0.1V - 600VAC	Volts: 0.1V - 600VAC
DC Voltage	400mV - 600V	660mV - 600V	600mV - 1000V	—	Amps: 0.01A - 1000AAC	Amps: 2mA - 200A AC
Diode Test	Yes	Yes	Yes	—	Power:	Power:
AC Current	40A - 400A	66A - 600A	600A - 1000A	2mA - 60A	Active: 0.01 - 600kW	Active: 0.1kW - 120kW
DC Current	40A - 400A	66A - 600A	600A - 1000A	—	Apparent: 0.001 - 600kVA	Apparent: 0.01 - 120kVA
Resistance	400Ω - 40MΩ	660Ω - 66MΩ	600Ω - 60MΩ	—	Reactive: 0.001 - 600kVAr	Reactive: 0.01 - 120kVAr
Capacitance	400nF - 4000μF	6.6μF - 66mF	6nF - 60mF	—	Harmonics: 45Hz - 65Hz	Harmonics: 30Hz - 1KHz
Frequency	0 - 10MHz	0 - 1KHz	60Hz-60mHz	—	1, 2-6, 7-8, 9-10, 11-15, 16-21	1, 2-6, 7-8, 9-10, 11-15, 16-21
Temperature	—	—	-40°C - 500°C	—	PF 0.3 - 1	PF 0.3 - 1
Continuity Test	Yes	Yes	Yes	—		

PEN TYPE TESTERS

	Multimeters			Non Contact Voltage Testers		Voltage tester
Code	MS8211	MS8211D	Code	MS8900	MS8907	MS8922A
Features	<ul style="list-style-type: none"> • Non contact voltage detector • Retractable tip • Auto Ranging • Auto Power off • MAX/Data hold 	<ul style="list-style-type: none"> • Logic level test • Retractable tip • Auto Ranging • Auto Power off • MAX/Data hold • Cat II 600V 	Description	<ul style="list-style-type: none"> • Auto power off • Pocket clip • Cat II 600V 	<ul style="list-style-type: none"> • Work light (torch) • Red and Green LED • Pocket clip • Cat II 1000V • Cat III 600V 	<ul style="list-style-type: none"> • Max test time: 30s (10 min recovery) • CAT III 400V
Ranges:			Ranges:			
AC Voltage	200mV-600V	200mV-600V	Test voltage AC	100-240V	50-1000V	12V-400V
DC Voltage	200mV-600V	200mV-600V	Test voltage DC	-	-	12V-400V
AC Current	-	20mA-200mA	Indication	Sound and light	Sound and light	LED bargraph
DC Current	-	20mA-200mA	Frequency	50-60Hz	50Hz/60Hz	50Hz/60Hz
Resistance	200Ω-20MΩ	200Ω-20MΩ				
Diode test	Yes	Yes				
Continuity	Yes	Yes				

NEW

SPECIALISED METERS

	Analogue Multi-Tester	Automotive Multimeter & Engine Analyser	SMD Tester	mA/V Process Calibrator	Process Thermocouple Calibrator	Capacitance Meter
Code	MS319	MS8239D	MS8910	MS7221	MS7220	MS6013
Features	<ul style="list-style-type: none"> • Easy Read Scale • Mirror Scale • Zero Ohms Adjust • Battery Test (1.5 / 9V) 	<ul style="list-style-type: none"> • Backlit LCD display • Dwell Test (Angle) 4 / 6 / 8 cylinder • Tach Test (Speed) 4 / 6 / 8 cylinder • Auto ranging • Max / Data hold • Auto Power Off • Cat III 600V 	<ul style="list-style-type: none"> • LCD display • Auto Ranging • Auto Power Off • Data Hold • Auto Scanning 	<ul style="list-style-type: none"> • Accurately measure loop currents • Measure voltage from process and PLC's • Source or Simulate 22mA loop currents • Simultaneous 24V loop supply and current measurement 	<ul style="list-style-type: none"> • Measure and simulate thermocouples J,K,T,E,R,S,B,N • °C / °F • Temperature scale: ITS-90, NIST 175 Thermocouple Type J: -200 - 1200°C K: -200 - 1370°C T: -200 - 400°C E: -200 - 950°C R: -20 - 1750°C S: -20 - 1750°C B: 600 - 1800°C N: -250 - 1300°C • Millivolt In/out: -10-75mV • Max Input Volts: 30V 	<ul style="list-style-type: none"> • Zero Adjustment • High Accuracy • Low battery display • 9 Ranges
Ranges	Volts AC: 10V - 1000V Volts DC: 2.5V - 1000V DC Current: 5mA - 10A Resistance: 0 - 10MΩ	200mV - 600V Volts DC: 200mV - 600V AC Current: 10A DC Current: 10A Resistance: 200Ω - 20MΩ Diode Test Continuity Test	Resistance: 300Ω - 30MΩ Capacitance: 3nF-30mF	DC Voltage in/out: 0-100mV, 0.1-10V DC Current in/out: 0-24mA Loop Power: 24V		Capacitance: 200pF - 20mF

TEST INSTRUMENTS, TOOLS & GENSETS

ENVIRONMENTAL METERS

	Infrared Thermometers		Digital Thermometer	Temperature/Humidity Meter	Combustable Gas Detector	Digital Sound Level
						
Code	MS6522A	MS6530A	MS6511	MS6508	MS6310	MS6700
Features	<ul style="list-style-type: none"> • Backlit LCD display • Read hold • Max / Min / AVG / display • Low battery display • Laser pointer • °C / °F 	<ul style="list-style-type: none"> • Backlit LCD display • Read hold • Max / Min / AVG / Differential display • Low battery display • Laser pointer • °C / °F 	<ul style="list-style-type: none"> • Thermocouple Types: K, J, T, E • Max / Min / AVG / Data hold • Auto power off • °C / °F / K 	<ul style="list-style-type: none"> • Backlit LCD Display • Sampling Rate: 400ms • °C / °F • Max / Min / Data hold • Auto power off 	<ul style="list-style-type: none"> • Easily find gas leaks • High sensitivity • Warm-up time: 2mins • Response time: 2sec • Alarm Range: 10-40% 	<ul style="list-style-type: none"> • Backlit LCD display • Max hold • Over range indication • Fast/Slow selection • Auto/Manual ranging • Auto power off • Bargraph indication • A/C Weighting • Date/Time display
Ranges	Temperature Range: -20°C - 300°C Resolution: ± 0.1°C / °F Repeatability: ± 0.1°C Optical Resolution: 10:1 Emissivity: 0,95	Temperature Range: -20°C - 850°C Resolution: ± 0.1°C / °F Repeatability: ± 0.5°C or ± 0.5% Optical Resolution: 12:1 Emissivity: 0,95	Temperature Range: K: -200°C - 1372°C J: -210°C - 1200°C T: -250°C - 400°C E: -150°C - 1000°C Resolution: 0.1°C/°F/K(<1000°) 1°C/°F/K(>1000°)	<ul style="list-style-type: none"> • Ambient Temp.: -20 - 60°C • Wet Bulb Temp.: -20 - 60°C • Dew Point Temp.: -50 - 60°C • Relative Humidity: 0-100% 	Gases Detected: <ul style="list-style-type: none"> • Natural gas • Methane • Ethane • Propane • Butane • Acetone • Alcohol • Ammonia • Steam • Gasoline • Jet Fuel • Napthta • Hydrogen Solvents • Carbon Monoxide • Lacquer Thinners 	Range: 30dB - 130dB Dynamic Range: 50dB Resolution: 0.1dB Freq range: 30Hz - 8KHz Sample Rate: 2/sec

Lightmeters		Anemometer	Anemometer/ Temperature/Humidity	Laser Tachometer	Contact Tachometer
					
MS6610	MS6612T	MS6252A	MS6252B	MS6208B	MS6208A
<ul style="list-style-type: none"> • High Accuracy • Data Hold on the separate sensor allow easy measurement from the optimal position • Silicon Photo Diode with Filter • Lead Length: 150cm 	<ul style="list-style-type: none"> • Auto Ranging • Auto Power Off • Max / Min / Peak / Data Hold • Relative Measurement • Zero Calibration • Analogue Bar Indication • Light Source Default Value Setting 	<ul style="list-style-type: none"> • Backlit LCD display • Bargraph Indication • Flow Area setting for volume calculation • Max/Min/Data Hold • Auto Power Off 	<ul style="list-style-type: none"> • Backlit LCD display • Flow Area setting for volume calculation • Max/Min/Data Hold • Auto Power Off • Ambient/Dew Point/Wet Bulb Temperature • °C / °F • Humidity • USB Interface (Windows) 	<ul style="list-style-type: none"> • Backlit LCD display • Non Contact measurement • Auto power off • Max/Min Data hold • Data logging 	<ul style="list-style-type: none"> • Backlit LCD display • Contact measurement • Auto power off • Max/Min Data hold • Data Logging
Measurement Range: 0-1999Lux 2000-19990Lux 20000-50000Lux Accuracy: ±5%	Lux: 0 - 200 000Lux Fc: 0 - 20 000Fc Candela: 0 - 999 900Cd	Meter/Sec: 0.8-40m/s km/h: 2.88 - 144km/h Other Units: ft/s, knots, mile/h, ft/m	Meter/Sec: 0.8-40m/s km/h: 2.88 - 144km/h Other Units: ft/s, knots, mile/h, ft/m Temperature: -10 - 60°C Relative humidity: 20 - 80%	Range: 50 - 99999RPM Measure Distance: 50-250mm	Range: 50 - 19999RPM





TEST EQUIPMENT



	Laser Distance Meters			Multi-Network Cable Tester	Wire Tracer	Professional Cable Locator
Code	MS6404	MS6408	MS64100	MS6810	MS6812	MS6818
Features	<ul style="list-style-type: none"> • Back-lit LCD Display • Pythagoras, Area, Volume Calculation • Continuous Measurement • Add/Subtract • Min/Max • Laser Pointer • Auto Power Off • Data Logging • Foot Level Measurement 	<ul style="list-style-type: none"> • Back-lit LCD Display • Pythagoras, Area, Volume Calculation • Continuous Measurement • Add/Subtract • Min/Max • Laser Pointer • Auto Power Off • Data Logging • Foot Level Measurement 	<ul style="list-style-type: none"> • Back-lit LCD Display • Pythagoras, Area, Volume Calculation • Continuous Measurement • Add/Subtract • Min/Max • Laser Pointer • Auto Power Off • Data Logging • Foot Level Measurement 	<ul style="list-style-type: none"> • Auto checks for open circuits, shorts, misplaced wires & reversals • Shield detection tests shield integrity • Quick & easy fault detecting 	<ul style="list-style-type: none"> • Designed to identify & trace wires or cables within a group without damaging the insulation • Continuity test • Volume control for increased sensitivity • Recessed ON/OFF button to prevent battery drain 	<ul style="list-style-type: none"> • Backlit Lid • Work Light (Torch) • Traces cable or conduit in walls or floor. • Traces for open or short cables. • Sensitivity of receiver adjustable.
Ranges	Distance: 0.05-40m Units: m/mm/In/Ft	Distance: 0.05-80m Units: m/mm/In/Ft	Distance: 0.05-100m Units: m/mm/In/Ft	Cable Types: UTP & STP twisted pair (RJ45) 10 Base-T T568A/B Token Ring Coaxial Cable (BNC) Max Cable Length: 200m	Emitter tone frequency: 1.5kHz (Single) 1.3-1.5kHz (Dual) Receiver frequency range: 100-300kHz	Display voltage range: 12-400VAC/DC. Depth of tracking depends on material and application. Single Pole: ±0-2m Dual Pole: ±0-0.5m Single Loop Line: Up to 2.5m

TEST PROBES

Code	ASL2	AL-12	AL-25	AL-26	FC-A23	PLSS150R Red	PLSS150B Black	SP1322-R Red	SP1322-BK Black
					Black & Red Insulated Crocodile Clips (pair)	Lead with 4mm Plug to fit Digital Multimeters and other test probes.		Banana Plugs 4mm Male Plug with plastic handle	
	Car Fuse Adapter								
Code	CF-01	CF-01S			KSY-6005R	FC-170A			
	MAXI-Blade	MINI-Blade			Black shaft with single pointed gripping jaws	Black and Red Test Probe (pair)			
					Red shaft with single pointed gripping jaws				
Code						FC-A15			
						Black and Red Test Clips (pair)			

INSTALLATION TEST EQUIPMENT







	Circuit Analyser	Digital Insulation Multimeter	Digital Insulation Testers		
					
Code	MS5908C	MS5208	MS5201 (1000V)	MS5205B (2500V)	MS5215 (5000V)
Features	<ul style="list-style-type: none"> • Loop Impedance/PSC • Voltage Test: L-N/N-E/Peak • RCD / GFCI test • Frequency • 5A/8A/10A load for Volt drop test • Wiring test function • Cat III 300V 	<ul style="list-style-type: none"> • DAR / PI Insulation mode • Backlit LCD display • Data logging • Auto / Manual ranging • Low Pass Filter • Max/Min/AVG/Data hold • Auto power off • Relative Measurement • Cat III 1000V 	<ul style="list-style-type: none"> • Constant Measuring Lock • Data Hold • Continuity Buzzer < 50Ω • Cat II 1000V • Cat II 600V 	<ul style="list-style-type: none"> • Backlit LCD Display • Auto Power Off • Lock / Data Hold • Min/Max/AVG • Compare Function • Timer Function • Storage Function • DAR/PI • Relative Measurement • Cat II 1000V • Cat II 600V 	<ul style="list-style-type: none"> • Large Backlit LCD Display • Broad Range of Testing Voltages • Auto DAR/PI calculation • Step Voltage Measurements & Temperature Compensation • Large Storage Memory • PC Communication • Robust & Durable • Cat II 1000V • Cat II 600V
Ranges	Line Volts: 85 - 265V Neutral/Ground: 0 - 10V Peak: 120 - 375V Freq: 45 - 65Hz Volt Drop: 0.1 - 99.9% Impedance (L/N/E): 0-3Ω RCD trip time: 1ms - 6.5s RCD trip Amp: 30mA GFCI trip time: 1ms - 6.5s GFCI trip Amp: 6mA	Insulation Function: 50V - 0-50MΩ 100V - 0-100MΩ 250V - 0-250MΩ 500V - 0-500MΩ 1000V - 0-2GΩ AC Voltage: 600mV - 750V DC Voltage: 600mV - 1000V Diode Test: Yes AC Current: 66mA - 400mA DC Current: 66mA - 400mA Resistance: 660Ω - 66MΩ Capacitance: 66nF - 66mF Frequency: 0-66kHz Temperature: -30°C-1300°C Continuity: Yes	Insulation Function: 250V - 0-200MΩ 500V - 0-200MΩ 1000V - 0-2000MΩ AC Voltage: 700V DC Voltage: 1000V Resistance: 200Ω	Insulation Function: 250V - 0-250MΩ 500V - 0-500MΩ 1000V - 0-10GΩ 2500V - 10-300GΩ AC Voltage: 750V DC Voltage: 1000V Resistance: 200Ω	Insulation Function: 250V - 0-250GΩ 500V - 0-500GΩ 1000V - 0-999GΩ 2500V - 0-2,5TΩ 5000V - 0-5TΩ AC Voltage: 750V DC Voltage: 1000V Resistance: 5TΩ Temperature: -10 - 70°C

Earth Resistance Testers					
					
Code	MS2302	MS2301	MS2307		
Features	<ul style="list-style-type: none"> • Backlit LCD Display • Auto Ranging • Auto Power Off • Bar Graph Display • Max / Min / AVG • Continuity Test • Relative Measurement • Data Logging • 2 or 3 Pole Testing • Cat III 300V 	<ul style="list-style-type: none"> • Auto Power Off • Auto Ranging • Data Hold • Buzzer On Symbol • Data Logging 99 Groups • Alarm Limit Setting • Jaw Size: 45 x 32mm • Cat III 150V 	<ul style="list-style-type: none"> • Auto Power Off • Dual Display dig/analog • Clock date/time • Average Value Measurement • Compensation Resistance • Alarm of Limit Value Groups • Alarm Limit Setting • Backlit LCD Display • Data Storage 100 Groups • USB 2.0 Interface 	Ranges: 3 Pole & 4 Pole Earthing Resistance Test Voltage: 20/48VAC Test Frequency: 94Hz / 105Hz / 111Hz / 128Hz / AFC Resistance: 0,1-30kΩ Selective Mode (3 Pole Clamp / 4 Pole Clamp) Test Voltage: 20/48VAC Test Frequency: 94Hz / 105Hz / 111Hz / 128Hz / AFC Resistance: 0,1-10kΩ Non-Auxiliary-polar mode (Clamp) Test Voltage: 48VAC Test Frequency: 94Hz / 105Hz / 111Hz / 128Hz / AFC Resistance: 0,1-150Ω 2 Pole Resistance (AC) Test Voltage: 20VAC Test Frequency: 94Hz / 105Hz / 111Hz / 128Hz / AFC Resistance: 0,1-30kΩ 2/4 Pole Resistance (DC) Test Voltage: 20VAC Resistance: 0,1-3kΩ Interfering Voltage / Current / Frequency Voltage: 1-50VAC/DC Current: 20mA ~ 2A Frequency: 16Hz ~ 400Hz Soil Resistivity ρ Test Voltage: 20/48VAC Test Frequency: 94Hz / 105Hz / 111Hz / 128Hz / AFC Resistance: 0,2-1000Ω·m RK (Wire Compensation) Test Voltage: 20/48VAC Test Frequency: 94Hz / 105Hz / 111Hz / 128Hz / AFC Resistance: 0,1-30kΩ Short Circuit Current ≤100mA	
Ranges	Earth Resistance: 0 - 4.0kΩ Voltage to Earth: 0 - 200VAC	Earth Resistance: 0-1200Ω Current: 100mA-20A			

INSTALLATION TEST EQUIPMENT

Earth Leakage Testers			Socket Outlet & RCD Tester	Schuko Socket Outlet & RCD Tester
MINITRIP 1	MINITRIP 2	MINITRIP 1/L	TEL1-3 (230V) TEL1-4 (240V)	SCHUKI-2
<ul style="list-style-type: none"> Wiring check 5-35mA Stepped output. Earth current test rated at 230VAC 50/60Hz Rotary switch selection Push button injection 	<ul style="list-style-type: none"> Analogue 10-50mA variable earth current Wiring check 50/60Hz Potentiometer selection of fault current 230VAC $\pm 15\%$ 	<ul style="list-style-type: none"> As MINITRIP 1 with 15A plug and lead. 	<ul style="list-style-type: none"> 3 phase Earth Leakage Tester Analogue Potentiometer selection of fault current 230VAC $\pm 15\%$ (L/N) Phase Selector Switch 50/60Hz 	<ul style="list-style-type: none"> Verifies that the wiring is correct (Neon light indication) RCD testing with variable fault current Trip settings 10 - 35mA
Phase Sequence Indicator	Digital Phase Indicator	CEE-Adaptor	Schuko Socket Outlet Tester	British Socket Outlet Tester
ST-850	890PR	SSP-8030	TV400-*	SCHUKI-3
<ul style="list-style-type: none"> Check phase sequence Open phase check Large alligator clips allow for easy connection & testing 90-600VAC 50/60Hz c/w Carrying case 	<ul style="list-style-type: none"> Non contact phase sequence testing Open phase testing Led and buzzer ind. Operational Voltage: 75-1000VAC 3PH Freq. Range: 45-65Hz Magnetic mounting bracket 	<ul style="list-style-type: none"> Designed to check the presence of open phase and phase sequence by LED and buzzer at the same time Operational Voltage: 200-480V AC 3 phase Freq. range: 20Hz-400Hz 	<ul style="list-style-type: none"> With Phase Rotation Indication - 3P+N+E Confirms correct wiring Indicates phase rotation Can be used with SCHUKI-2 to test RCD * Add current rating to code: 16A, 32A 	<ul style="list-style-type: none"> Confirms correct wiring of outlet Output via glowing lamps
Hand Crank Insulation Tester	Hand Held Insulation Tester	Digital Insulation Tester	Digital Insulation Tester	
NB311110	EM580F (500V)	IT811A (2500V)	2803IN (max 5kV)	2804IN (max 10kV)
<ul style="list-style-type: none"> Insulation Resistance <p>Test voltage 500V Ohm Meter: 0Ω to 500MΩ</p>	<ul style="list-style-type: none"> Fixed Time or Test Locked Data Hold Overload protection Backlit LCD Display Cat III 600V <p>Test Ranges: 125V: 2/20/200MΩ 250V: 20/200/500MΩ 500V: 20/200/1000MΩ AC/DC Voltage: 600VAC/DC</p>	<ul style="list-style-type: none"> Auto discharge function Backlit LCD display Data hold Overload protection Backlit LCD Display Cat III 600V <p>Test Voltage: 250/500/1000/2500V Resistance: 1m-20GΩ AC Voltage: 0-750VAC</p>	<p>Designed for use by Panel Builders</p> <ul style="list-style-type: none"> Non Destructive Test Limited Current <ul style="list-style-type: none"> Insulation resistance Auto ranging on all ranges Bargraph indicates test voltage; rise and decay can be observed during tests <ul style="list-style-type: none"> Visual and audible warning if external voltage is present <ul style="list-style-type: none"> Enersave™ feature to extend battery life 2 Lines x 16 char. large LCD Auto-off Show test time duration (up to 99.9s) for easy comparison 	<ul style="list-style-type: none"> Insulation resistance Auto ranging on all ranges Bargraph indicates test voltage; rise and decay can be observed during tests <ul style="list-style-type: none"> Visual and audible warning if external voltage is present <ul style="list-style-type: none"> Enersave™ feature to extend battery life 2 Lines x 16 char. large LCD Auto-off Show test time duration (up to 99.9s) for easy comparison
			<p>Test Voltage (DC V): 0.5 / 1 / 2.5 / 5kV Measuring Ranges: 0-25 / 0-50 / 0-125 / 0-250GΩ</p>	<p>Test Voltage (DC V): 1 / 2.5 / 5 / 10kV Measuring Ranges: 0-50 / 0-125 / 0-250 / 0-500GΩ</p>

INSTALLATION TEST EQUIPMENT

	Analog Insulation Tester	Digital Insulation Tester	High Voltage 5kV Insulation Tester
	<p>Designed for SANS 10142 Testing</p> 		<div style="display: flex; align-items: center;"> <div style="background-color: red; color: white; padding: 5px; transform: rotate(-15deg); font-weight: bold; margin-right: 10px;">NEW</div>  </div>
Code	2732IN (1000V)	2751IN (1000V)	6305AIN (5000V)
Features	<ul style="list-style-type: none"> High quality Taut Band movement Two continuity test ranges on "low ohms" Compact and lightweight AC voltmeter with linear scale Automatic discharge of capacitive & inductive circuit Live warning and display of external voltage presence Fuse, air gap, crowbar and overload protected Low battery consumption Mirror scale Push and turn locking switch for continuous and hand free testing 	<ul style="list-style-type: none"> Timer for test function (count 3-5 minutes) Automatic circuit discharge Continuity test with three phases External voltage warning indication Fuse protection Data hold function Auto power off function 	<ul style="list-style-type: none"> PI (Polarization Index) indication DAR (Dielectric Absorption Ratio) indication Auto-ranging on all insulation ranges Optical USB to RS-232 data transmission Visual and audio warning of external voltage presence ($\geq 30V_{ac}$ or $\geq 30V_{dc}$) Auto-hold function to freeze reading Overload protection • Auto-off function Adjustable testing duration: 1~30 minutes Displays testing duration for insulation measurement Data can be downloaded and saved to a PC or transferred for real-time display 200 measurement results can be saved in the memory and recalled on the display
Ranges	<p>Insulation Resistance: Test voltage: (DC V) 250V / 500V / 1000V Measuring ranges: 0-100MΩ / 0-200MΩ / 0-400MΩ ($\geq 1.0mA$ SC) Continuity: Measuring range: 3Ω / 5Ω ($>200mA$ SC) AC Voltage: 0-600V AC Power source: 1.5V (AA) x 6</p>	<p>Insulation Resistance: Test voltage (DC V): 250V / 500V / 1000V Measuring ranges (auto ranging): 0-20MΩ / 0-200MΩ / 0-2000MΩ (1mA) Continuity: Measuring range: 0-20Ω / 0-200Ω / 0-2000Ω (200mA) AC Voltage: 0-600VAC Power source: 1.5V (AA) x 6</p>	<p>Insulation resistance: Test voltage: 500V / 1000V / 2500V / 5000V Measuring ranges: 1TΩ / 2TΩ / 5TΩ / 10TΩ Voltmeter: 30~600V AC/DC Power source: 1.5 (C) x 8</p>
	Analog Earth Resistance Tester	3 Wire Earth Resistance Tester	Digital Loop/PSC/Load Tester
	<div style="display: flex; align-items: center;"> <div style="background-color: red; color: white; padding: 5px; transform: rotate(-15deg); font-weight: bold; margin-right: 10px;">NEW</div>  </div>	<div style="display: flex; align-items: center;"> <div style="background-color: red; color: white; padding: 5px; transform: rotate(-15deg); font-weight: bold; margin-right: 10px;">NEW</div>  </div>	<div style="display: flex; align-items: center;"> <div style="background-color: red; color: white; padding: 5px; transform: rotate(-15deg); font-weight: bold; margin-right: 10px;">NEW</div> <div style="text-align: center;"> <p>Designed for SANS 10142 Testing</p>  </div> </div>
Code	2705ER	2720ER	2725LP
Features	<ul style="list-style-type: none"> High quality Taut Band movement Capable of measuring earth resistance and earth voltage 2mA measuring current permits the testing of earth resistance without tripping earth leakage current breakers in the circuit under test. 	<ul style="list-style-type: none"> Capable of measuring earth resistance and earth voltage 2mA measuring current permits the testing of earth resistance without tripping earth leakage current breakers in the circuit under test. 	<ul style="list-style-type: none"> Combined prospective short circuit current, loop and load tester Measures the voltage drop as if 16A was flowing between Line and Neutral Display voltage as if 16A flowing between Line and Neutral (V at 16A) Loop test for L-E PSC between L-N Single smart push button operation: ON, Scroll through results and menus Checks wiring integrity (LEDs) Auto off/auto ranging (software range)
Ranges	<p>Earth resistance: 0-10Ω / 0-100Ω / 0-1000Ω Earth voltage: 0-30 VAC (40-500Hz) Measuring System: Earth resistance by constant current inverter 820 Hz, 2mA approx. Power source: 1.5V (AA) x 6</p>	<p>Earth resistance: 0-20Ω / 0-200Ω / 0-2000Ω Earth voltage: 0-200 VAC (40-500Hz) Measuring system: Earth Resistance by constant current inverter 820Hz approx. 2mA Power source: 1.5V (AA) x 6</p>	<p>Loop impedance range L-E: 0.03-2000Ω Test currents in each loop: 11.76A at 230V / 50Hz Voltage measurement: L-N 50 to 280VAC (Sine) Load current for volt drop (L-N): 16A (Calculation) PSC current (L-N) max: 6kA at 230VAC supply Operating voltage: 230V\pm20V at 50Hz Power Source: 1.5V (AA) x 6</p>

INSTALLATION TEST EQUIPMENT

	Digital Electrical Network Analyzer	Digital RCD/GFCI/ELCB Tester	Digital Earth Leakage Tester
	<p>Designed for SANS 10142 Testing & Fault Finding</p>	<p style="color: red; font-weight: bold; font-size: 1.2em;">NEW</p> <p>Designed for SANS 10142 Testing</p>	<p>Robust Design for Mining Applications</p>
Code	2726NA	2712EL	2820EL
Features	<ul style="list-style-type: none"> • Built-in Earth tester (No peg required) • Built-in Loop/PSC tester • Built-in Voltmeter • Built-in Wiring checker • One push button smart control • Display L-N and L-E voltages • Display Line path impedance • Display Earth path impedance • Display Neutral path impedance • Display PSC Line to Neutral • Display PSC Line to Earth • Re-scroll through previous results • Bat. ok/low battery indicator • Auto-off function • Rugged Case • Ultra low power consumption 	<ul style="list-style-type: none"> • 2 Lines x 16 characters LCD • Very low consumption • Accurate digital readout of disconnection time • Automatic data hold function • Over temperature, Over voltage • Fuse protection • Zero crossing circuitry permits testing start at 0° or 180° • Disconnection phase polarity shown on LCD display • Auto off and off override • Polarity trip indicator (positive or negative phase referenced to earth) • Wiring polarity indicator 	<ul style="list-style-type: none"> • Checks ELCB trip time & trip point (sensitivity) • 2 Test types for instantaneous ELCBs or inverse and fixed time delay ELCBs • Auto off and auto ranging • Start Phase angle selection (0° / 180°) • Indicates tripping phase angle • Impact resistant enclosure • Over temperature shut-down • Transient protection • Suitable for heavy industrial use • Fused
Ranges	<p>Loop / Earth / Line Impedance: 0.03-2000Ω (auto-ranging)</p> <p>Prospective short circuit (PSC): 0~6kA at 230VAC</p> <p>Operating voltage: 50V~275VAC (50Hz)</p> <p>Best performance at rated voltage: 230VAC ± 20V</p> <p>Voltage Measurement (L-N)(L-E): 50-280VAC (Sine)</p> <p>Power Source: 1.5V (AA) x 6</p>	<p>Operating voltage (L-E) (50Hz or 60 Hz): 230 VAC</p> <p>Current Settings: 3mA, 5mA, 10mA, 15mA, 20mA, 30mA, 50mA, 100mA, 150mA, 250mA, 300mA, 500mA</p> <p>Start phase angle setting: 0° & 180° selectable</p> <p>Over-temperature protection: Yes (3 sensors)</p> <p>Voltmeter (L-E): 20VAC ~ 280VAC (50Hz or 60Hz)</p> <p>Timer resolution: 1ms (Max. Time=2.999s)</p> <p>Timer accuracy: ±2ms</p> <p>Power source: 1.5V (AA) x 6</p>	<p>Trip current: 0-1A at 317VAC / 50Hz</p> <p>Trip current resolution: 1mA</p> <p>Operating voltage: (L-E) 100 - 450V</p> <p>Phase angle setting: 0°&180° selectable</p> <p>Timer-max: 99.999s</p> <p>Timer resolution: 1ms</p> <p>Typical Accuracy:</p> <p>Trip-current: ±1%rdg±1mA</p> <p>Trip-time: ±1%rdg±1dgt</p> <p>Voltage: ±3%rdg±1dgt</p> <p>Power source: 1.5V (AA) x 8</p>

DIGITAL ELECTRICAL COMPLIANCE TEST CASE



Electricians Test Case

Electricians electrical compliance test case, instruments required to test for issue of electrical compliance certificates.

	CK-1		
Case Includes	2751IN	Digital Insulation Tester	(Page 490)
	TEL1-3	RCD Tester	(Page 489)
	MY60	Digital Multimeter	(Page 483)
	ST-850	Digital Phase Indicator	(Page 489)
	MS8900	Voltage Finder	(Page 485)
	2726NA	Digital Electric Network Analyser	(Page 491)

INSTALLATION TEST EQUIPMENT

Digital Insulation Tester



Code	TIN4D (5kV)	TIN5D (10kV)	TIN6D (10kV)
Features	<ul style="list-style-type: none"> • Displays Insulation test time • Displays warning • Fully protected crow bar • Auto ranging • Insulation test time interval up to 99 sec 	<ul style="list-style-type: none"> • Auto Ranging on all Ranges • Display insulation test time • Displays Warning • Fully Protected Crow bar • Insulation test time interval up to 99 sec 	<ul style="list-style-type: none"> • Heavy Duty Carry Case • Silicone test leads • Anti-skid/vibration absorbing enclosure • Live circuit warning • Auto Discharge / Range / Off • Insulation test time interval up to 99 sec
Ranges	Insulation test voltages: 500V / 1000V / 2500V / 5000V Insulation Resistance: 0-30GΩ / 0-60GΩ / 0-125GΩ / 0-250GΩ Accuracy: ± 3% reading + 2 Digit Output Current Limit: 50μA to 100μA Live Warning: >500V Power Source: 8 x 1.5V C Batteries Alkaline Standard Accessories: Carry Pouch	Insulation test voltages: 1000V / 2500V / 5000V / 10000V Insulation Resistance: 0-60GΩ / 0-125GΩ / 0-250GΩ / 0-500GΩ Accuracy: ± 3% reading + 2 Digit Output Current Limit: 50μA to 100μA Live Warning: >500V Power Source: 8 x 1.5V C Batteries Alkaline Standard Accessories: Carry Pouch	20 Insulation test voltages: 500V - 10KV Insulation Resistance: 25GΩ - 500GΩ Output power Limit: 1W Accuracy: ± 3% reading + 1 Digit Short Circuit Current: Max 1.25mA Power Source: 8 x 1.5V C Batteries Alkaline Standard Accessories: Carry Pouch

Digital Insulation Tester

Analogue Insulation Tester



Code	T1851 (1000V)	T1832 (1000V)	T1800 (1000V)
Features	<ul style="list-style-type: none"> • Live Circuit Indication • Live Circuit Warning • Auto Discharge • AC voltage measurement • Auto Power Off • Continuity Buzzer 	<ul style="list-style-type: none"> • Taut Band Movement • Live Circuit Indication • Auto Discharge • AC voltage measurement • Rugged Construction • Nulling of Test Leads • Continuity Buzzer • Mirror Scale 	<ul style="list-style-type: none"> • Taut Band Movement • Live Circuit Indication • Colour Coded Scale • Auto Discharge • Heavy Duty Carry Case • AC Voltage Measurement
Ranges	Insulation test voltages: 250V / 500V / 1000V Insulation Resistance: 0-200MΩ / 0-2000MΩ (1mA) Accuracy: ± 1.5% reading + 5 Digit Continuity Range: 0-2kΩ (210mA) Voltage Measurement: 0-500VAC Power Source: 8 x 1.5V AA Batteries Alkaline	Insulation test voltages: 250V / 500V / 1000V Insulation Resistance: 0-100MΩ, 0-200MΩ, 0-400MΩ (1mA) Accuracy: ± 5% of Indicated Value Continuity Range: 0-50Ω (200mA) Voltage Measurement: 0-500VAC Power Source: 8 x 1.5V AA Batteries Alkaline	Insulation test voltages: 250V / 500V / 1000V Insulation Resistance: 0-100MΩ, 0-200MΩ, 0-400MΩ (1mA) Accuracy: ± 5% of Indicated Value Continuity Range: 0-50Ω (145mA) Voltage Measurement: 0-500VAC Power Source: 8 x 1.5V AA Batteries Alkaline

NEW

INSTALLATION TEST EQUIPMENT

	Digital Earth Resistance Tester	Analogue Earth Resistance Tester
		
Code	T1820	T1805
Features	<ul style="list-style-type: none"> • Earth voltage detection • 2mA earth resistance to test • 2 and 3 Wire Testing 	<ul style="list-style-type: none"> • Large display • Taut band movement • 2 and 3 Wire tester
Ranges	Resistance: 20Ω, 200Ω, 2kΩ Earth Voltage: 200VAC (40 - 500Hz) Measuring System: Earth resistance by constant current inverter, 820Hz, 2mA Approx Resistance Accuracy: ±2% rdg + 2 Digit Voltage Accuracy: ±1% rdg + 2 Digit Power Source: 8 x 1.5V AA Batteries Standard Accessories: Test Leads, Earth Spikes and Shoulder Belt	Resistance: 10Ω, 100Ω, 1kΩ Earth Voltage: 30VAC (5kΩ/V) Measuring System: Earth resistance by constant current inverter, 820Hz, 2mA Approx Withstand Voltage: 1500VAC (one minute), ±1.8% + 4 Digit Resistance Accuracy: ±2.5% of full scale Voltage Accuracy: ±1% of full scale Power Source: 8 x 1.5V AA Batteries Standard Accessories: Test Leads, Earth Spikes and Shoulder Belt
	Loop/PSC/Load Tester	
		
Code	T1825 (1000V)	T1826 (1000V)
Features	<ul style="list-style-type: none"> • Load/No load tester • Prospective short circuit current (PSC) • Volt drop test • Micro processor controlled • Test up to 100A (6kA) circuit breakers • 3-Phase system test • Designed to SANS 10142 	<ul style="list-style-type: none"> • Fault finding • Electrical network analyser • Earth resistance without peg • Analyse to SANS 10142 • Loop test for L-E, L-N and PSC
Ranges	Loop: 0~2000Ω PSC: 0 ~ 6kA @230V(L-N) Operating Voltage: 50 ~275VAC (50 or 60Hz) Test Current: 12A (Load Volts shown as @16A) Power Source: 8 x 1.5V AA Batteries Alkaline Standard Accessories: Carry Case, Strap, Leads	Loop: 0~2000Ω PSC: 0 ~ 6kA @230V (L-N) Operating Voltage: 230VAC ± 20V (50Hz) Test Current: 11.76A Neutral Wire Resistance: 0.01 - 2000Ω Live Wire Resistance: 0.01 - 2000Ω PSC Current (L-N): Max 6kA @ 230V AC PSC Current (L-E): Max 6kA @ 230V AC Power Source: 8 x 1.5V AA Batteries Alkaline Standard Accessories: Carry Case, Strap, Leads
	ELCB Tester	
		
Code	TEL28 (1000V)	
Features	<ul style="list-style-type: none"> • Micro-processor controlled • Direct read out of time/current • Voltage measurement • Suitable for industrial, mining and domestic environments • 3 Phase - Each phase tested separately • Designed to SANS 10142 	
Ranges	Rated tripping current: 0 to 1000mA, ± 1mA Resolution: 1mA Operating Voltage (L-E): 100 to 450VAC, Maximum Trip Time: 100 secs (1mS resolution), Phase Angle Setting: 0 and 180° selectable Power Source: 8 x 1.5V AA Batteries Alkaline Standard Accessories: Carry Case, Strap, Leads	

TEST INSTRUMENTS, TOOLS & GENSETS

POWER QUALITY ANALYSERS



Code	MI-2892
Voltage: TRMS, peak, crest factor	4 Ch Cat III / 1000V
Current: TRMS, peak, crest factor	4 Ch (Auto clamp detection)
Power: P, Q, S	✓
Unbalance, flicker measurement	✓
Harmonic and THD measurement	✓
Interharmonics	✓
Energy (P, Q, Forward/backward)	✓
Events (interruptions, swells, dips)	✓
Inrush currents	✓
Waveform/Inrush	✓
Transients recording	✓
Power quality analysis EN 50160	✓
Recording of adjustable alarms	7
Temperature measurement	✓
Power factor $\cos \phi$	✓
PC software (Included)	PowerView 3

Standard Set	
1-phase flexible current clamps	4x 3000 / 300 / 30 A
Test probe/clip/leads	5 / 5 / 5
Temperature probe	1
Memory	8GB SD supplied
Communication	RS232, USB and Ethernet
PSU & Batteries	1
Soft carrying bag	1

Accessories	
Code	Description
A1069	Mini Clamp 100A/1V (range 2A - 100A)
A1122	Mini Clamp 5A/1V (range 2A - 100A)
A1039	Connection cable for current clamp
A1037-M	Current transformer 5A/1V
A1033-M	Current clamp 1000A/1V
A1257	3-phase flexible current clamps 3000/300/30A/1V
S2014	Safety fuse adapter, 3 pcs
A1198	Magnetic contact probe



Efficiency Terminal - Portable Mains Analyser

Professional measuring instrument, indispensable for sampling up to 50 electrical parameter such as Voltage drops, Harmonics, Digital values, Power values Circuit currents. Using CT, Split core CT and Rogowski coils. The internal rechargeable battery gives up to 8 hours of autonomy.

Code	1114HX
Reliable	Extremely precise measurement on three phase and single phase systems, with up to 250 days of continuous recording.
Versatile	A wide range of electrical loads. Rogowski current probes (3 included) allow measurement of currents from 5A to 2000A.
Easy Operation	Easy programming of parameters and measurement ratios. USB port allows for quick and easy transfer of data to a PC.

Features

- Records voltage peaks with time duration of 10ms
- Registers up to 25th harmonic (voltage / current)
- Measurements in true value (TRMS) & 4 quadrants
- Clear indication of measured parameters and values
- Easy programming of parameters and ratios via keypad
- Last 3 days display (Voltage, Current, Power, COS ϕ , THD)
- 12 Energy totalisers on 4 quadrants
- Clock and Calendar, Graphical display
- Weight 800g

Supply Includes

- 3 x Rogowski Coils (2.5m cables)
- 1 x 12V Lithium Ion battery
- 1 x 230VAC/12VDC adaptor
- 1 x User manual
- 1 x USB cable (1.5m)
- 4 x 2.5m Test Leads
- 1 x ES3 Software

Compliances

- EN55011 ClassA
- EN61000-4-2
- EN61000-4-3
- EN61000-4-4
- EN61000-4-5
- EN61000-4-6
- EN61000-4-11
- EN60204-1

ES3 Management & Control Software

Measurement and analysis of consumption of energy to allow accurate planning and implementation of actions to improve production and efficiencies. **ES3** software compares the relationship between the invoiced data from the power supplier to the real measured consumptions on site providing accurate analytical billing data.



DATALOGGING EQUIPMENT

Multimeter Data Logger		AC/DC Power Clamp Meter & PC Adaptor & Software			
				 Order Separately	
Code	PROVA 901	TES-3063 (Clamp Meter)		TES-3064 (PC adaptor)	
Features	<ul style="list-style-type: none"> • Dual Input Channels • Compare Voltage at two different locations • Read Voltage and Current at the same time • Standalone Data Logging of 10 708 Records both Channels • Optical Isolated RS-232C ASCII Interface, application software • Bandwidth 200kHz • Basic Accuracy 0.02% (DC) and 0.1% (AC) 	<ul style="list-style-type: none"> • 1600 Point Data logging function • True Power/Apparent Power/ Power Factor Measurement • True RMS. V, A, W • 4 digits with 2" LCD Display • MIN/MAX/AVG Measurement • Amp/Voltage Frequency Measurement • PEAK HOLD Detector • 3 Phase adaptor for 3 phase power measurement • Peak hold/Data hold 		<ul style="list-style-type: none"> • To down load the data into the computer from datalogging memory of TES-3063 • Communicates with PC via RS-232 for further data analysis and reports 	
Ranges	DCV/ACV: 60.000mV-1000.0V DCA/ACA: 600.00µA-10.000A Resistance: 999.99Ω - 40MΩ Capacitance: 60.00nF-600.0µF Frequency: 1Hz-2.000MHz Duty-Cycle & Diode Test Continuity Test	Volt: 10V - 600VAC Amp: 2mA - 200A Active power: 0.1 - 120KW Apparent: 0.01 - 120KVA Reactive: 0.01 - 120KVAR PF (cap): 0.3 - 1 PF (ind): 0.3 - 1		 RS232	
Temperature/Humidity & Air Pressure Datalogger		Sound Level Datalogger	DC Current or Voltage Datalogger		AC Current & Voltage Datalogger
Code	ST-174B	ST-173	ST-171A	ST-171V	ST-175CV1
Features	<ul style="list-style-type: none"> • Manual & Automatic start mode • Alarm set-up & indication • Recording & low battery indication • USB port for data traffic & power • Status indication via Red/Yellow & Green LED 	<ul style="list-style-type: none"> • Max - Min measurement • Alarm value set-up / A&C Weighting • Normal & Peak Mode • Fast and slow response • Manual/Auto Mode 	<ul style="list-style-type: none"> • Freely selectable measuring cycle • USB Data Download • Alarm display if parameters exceeded 		<ul style="list-style-type: none"> • True RMS reading • USB-PC Interface (c/w software) • Single channel input • c/w Probes for 1PH, current and voltage measurements
Ranges	Data memory: 10 000 readings Sampling Rate: 1 min to 18 Hrs Data Output: USB Temp Range: -40 to 70°C/ -40° to 158°F Resolution: 0.1°C/0.1°F Humidity Range: 0 to 100%RH Resolution: 0.1%RH Air Pressure: 950 to 1050hPa Resolution: 0.1hPa	Sampling Rate: 1sec - 24hr Accuracy: ±1.4db Freq Range: 31.5Hz to 8kHz Dynamic Range: 50db Level Ranges: Auto: 30db - 130db Time Weighting: Fast(125ms), Slow(1s) Reading Memory: 129920 points for dBA or dBC Data Output: USB Data	Status display: 2 LEDs Current Range: 4 to 20m ADC Accuracy: ±1%/±1Count Memory: 32000 readings Sampling Rate: 2sec - 24hrs	Status display: 2 LEDs DC Voltage Range: 0 to 30VDC Accuracy: ±0.5%+1 Memory: 32000 readings Sampling Rate: 400Hz to 24 hrs	Current: 10 - 200A Voltage: 10 - 600VAC Sampling Rate: 1sec - 24hr Reading Memory: Up to 100 000

20MHZ HANDHELD DUAL CHANNEL SCOPE METER

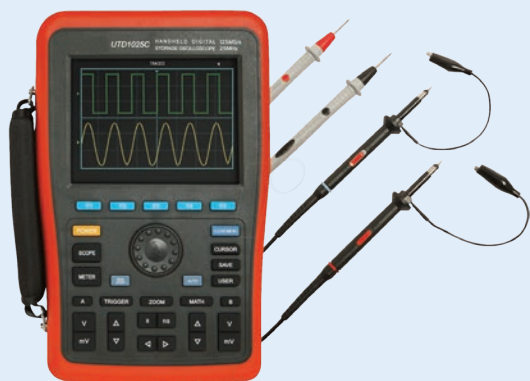

DMM Functions

DCV/ACV: 600m/6/60/600/1000V(750V),
±1.0%/1.2%

DCA/ACA: 6/60m/600m/6A, ±1.2% / 2.0%

OHM: 600/6k/60k/600k/6M/60MΩ, ±1.2%

CAP: 6n/60n/600n/6μ/60μ/600μF, ±4.0%

Audible continuity & diode test

Features

- DMM built with dual-channel DSO, colour LCD display
- Automatic waveform and status configuration
- Edge, Pulse, Video and Alternate triggers
- Waveform maths & FFT, auto & cursor measurement
- Display zone for precision waveform analysis
- Screen copy, waveform recording and replay
- Built-in 6 digits frequency counter
- USB interface, system software upgradeable
- AC power (100~240V, 50/60Hz) or batteries
- Dimensions & weight: 268 x 168 x 60mm, approx 1.8kgs
- Accessories: AC adaptor, interface wire & software, test leads & probes

Scope Meter

Code	UTD1025C
Bandwidth	DC ~ 25MHz, dual channels
Real-time Sampling Rate	125M Sa/s
Equivalent Sampling Rate	25G Sa/s
Horizontal sensitivity	10ns/div-50s/div, ±0.01%
Record Length	2 x 512k
Vertical sensitivity	5mV/div-5V/div, ±5%
Vertical resolution	8 bit
Rise time	14ns
Trigger type	Edge, Pulse width, Video, Alternate
Max. input voltage	400V DC + AC peak
Input impedance	1MΩ //21pF
Waveform maths	+, -, *, /, FFT
Auto measurement	Vpp, Vmax, Vmin, Vtop, Vbase, Vmid, Vamp, Vavg, Vrms, +Overshoot, -Overshoot, Freq, Period, Risetime, Falltime, +Width, -Width, ±delay, ±duty
Cursor measurement	ΔV, ΔT
Frequency counter	6 digits
Interface	USB2.0 Host
Storage (internal/USB)	10 waveforms + 10 setups
Display	5.7 inch 320 x 240 pixels color LCD

HIGH VOLTAGE SAFETY GLOVES & MATS

CE Approved



CUST.GI



VPG90

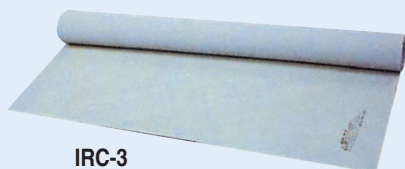

IRC-3

Safety Gloves

Test V	2500V	5kV	10kV	20kV	30kV
User V	500V	1kV	7.5kV	17kV	26.5kV
Code	Code	Code	Code	Code	Code
8	GI2,5-8	GI5-8	GI10-8	GI20-8	GI30-8
9	GI2,5-9	GI5-9	GI10-9	GI20-9	GI30-9
10	GI2,5-10	GI5-10	GI10-10	GI20-10	GI30-10
11	GI2,5-11	GI5-11	GI10-11	GI20-11	GI30-11

Accessories

Code	Description
CUST.GI	Protective plastic case for gloves
VPG90	Pneumatic Tester. Inflates the gloves and you can detect perforation on dielectric

26,5kV Insulated Rubber Safety Mat - 3mm thick x 1 m wide – priced per meter

Code	Description
IRC-3	3mm x 1 meter (w). Voltage test 30000V, max use voltage 26500V

NEW

HIGH VOLTAGE TESTERS



HVD Range - High Voltage Detector

Code	HVD13AC	HVD32AC	HVD33AC
System Voltage	6.6-132kV	11-33kV	44-132kV
Threshold Range*	2.5kV	2.5kV	10kV

Technical Overview

Spark Protection	The detector will not be damaged as a result of spark discharge while making contact with the conductor under test
Bridging Protection	The detector and its accessories will not cause flashover between live parts of the installation or between live parts of the installation and earth/ground
Current Consumption	30 mA maximum
Test Button	Tests and arms the detector when pressed and released
Visual Indicator (2Hz)	Red lamp (voltage present), green lamp (safe)
Audible Indicator	Buzzer - 3.1 kHz tone modulated at 2 Hz - 70 dB (1.5 metres)

Mechanical

Y Electrode	Material: Stainless Steel. Size (mm): 40Ø x 35L
Standard Accessories	Carry bag, Cleaning kit, Rose Connector, Y Contact

- Checks if HV system is alive or dead
- All weather use (indoor or outdoor)
- * Non standard threshold voltages can be set outside the range to suit customers requirements



THVD Range - Contact Capacitive High Voltage Detector

Code	T213HVD	T217HVD	T218HVD	T219HVD	T220HVD
System Voltage	11kV	11/33kV	6/22kV	44/132kV	6.6/132kV
Threshold Set within Range	1.65-4.4kV	3.3-4.95kV	1.8-2.7kV	6.6-19.8kV	1.65-14.6kV
Response Time	<1 Sec	<1 Sec	<1 Sec	<1 Sec	<1 Sec
Auto-OFF	±3 Min	±3 Min	±3 Min	±3 Min	±3 Min
Bridging Protection	Yes	Yes	Yes	Yes	Yes
Spark Protection	Yes	Yes	Yes	Yes	Yes
Battery Low	<7V	<7V	<7V	<7V	<7V
Threshold	3.02kV	4.12kV	2.5kV	13.2kV	2.5kV
Battery Current	<30mA	<30mA	<30mA	<30mA	<30mA
Green = Armed	Yes	Yes	Yes	Yes	Yes
Red = V Detected	Yes	Yes	Yes	Yes	Yes

- Self-starting and automatically activated when the High Voltage is applied to the contact electrode
- Use on sinusoidal (50 or 60Hz) High Voltage Systems
- Models are available to cover systems voltage from 6.6kV to 132kV
- IEC 61243-1 for voltages above 1kV 50/60Hz
- Check system is dead or alive



High-Prox Voltage Proximity Detector

Code	T175HP
Ranges	240V, 3.3kV, 6.6kV, 11kV, 22kV, 33kV, 66kV, 132kV, 275kV
Detection	Selected range is detected at approx. 25cm from the voltage source 240V ±10cm, 33kV ±50cm
Self-Test	Selection
Indicators	Bright Red LED and buzzer

Model Specifications

Power Source	3 x 1.5V C Batteries
Standard Accessories	Carry Pouch

- Non-contact high voltage detector
- Ten switch-selectable voltage sensitivity ranges
- Lightweight
- Audible and visual indication of live voltage
- Rose adaptor
- Check high frequency radiation

HIGH VOLTAGE TEST EQUIPMENT



When approaching a high voltage source the buzzer will sound and LED will flash to alert the user.
Waterproof Design.

Personal Safety Voltage Detector

Code	286-SVD
Sensing Distance	800mm @ 11,4kV 50/60Hz
Volume	70dB @ 1m
Size	59 x 56 x 18mm



High Voltage Proximity Detector

Code	277HP
The 277HP is a voltage (non contact) proximity detector for checking for the presence of AC voltages in cables, wall outlets, fuses etc. AC voltages from 50V to 132kV.	
<ul style="list-style-type: none"> • 2 selectable ranges: LOW: 50 - 1.5kV HIGH: 1.5kV - 132kV • Power consumption OFF: Less than 5µA ON: Less than 40mA • Test Button: Test the system prior to measurement • Operating Temperature: 0°C - 40°C • Dimensions (L x W x Ø): 318 x 75 x 71mm • Power Source: 1 x 9V (6F22) battery • Standards: EN61326-1 / EN61000-4-2 / EN61000-4-3 • Supplied with: Manual, Battery, Carry case. 	

Accessories - Hotsticks



Code	Description
HS-*	Meets IEC 60855 Rated at 100kV per 300mm / 5 minutes

*Add Length to Code: **120** = 1200mm long,
800 = 800mm long, **500** = 500mm long

Disconnect Hook



HOK-HS166

Fuse Extractor



ADP-HS120

High Voltage Multifunction Phasing Sticks



Specifications	PC-7K	PC-11K	PC-22K	PC-33K	PC-44K
System Voltage	6.6kV	11kV	22kV	33kV	44kV
Full Scale Voltage	8kV	12kV	24kV	35kV	48kV
Maximum Voltage	9kV	15kV	30kV	40kV	55kV
Total Resistance	3.95MΩ	6.78MΩ	13.5MΩ	20.1MΩ	27MΩ
Neon Threshold	1.2kV	1.2kV	1.2kV	1.2kV	1.2kV
Neon Fully lit @	1.5kV	1.5kV	1.5kV	1.5kV	1.5kV
Handle Length	775mm	775mm	765mm	765mm	765mm
Front End Length	400mm	400mm	460mm	610mm	760mm
Total Length	1105mm	1105mm	1225mm	1375mm	1525mm
Total Weight	±1.2kg	±1.2kg	±1.3kg	±1.4kg	±1.5kg
Handle Material	Silicone, Front end: Fibre glass wound tubing				
Operating Temperature	-25°C to +55°C				
Operating Humidity	20 to 96% RH				

- Lightweight, Robust
- Designed for maximum safety
- Carry case included
- No user assembled parts
- Dual colour coded scale
- Measure & test phase to earth & phase to phase
- Self-powered - No Battery
- Grounded or ungrounded systems
- High immunity to interference fields

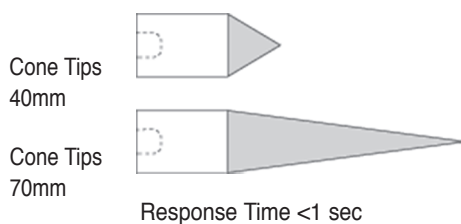

Accessories - (for all models)

Code	Description
PC-BK	90° bends (pair)
PC-C1K	40mm cone tips (pair)
PC-C2K	70mm cone tips (pair)

RMB36
c/w case



Phasing and Voltage Detector of MV Presence / Absence by Visual Signalling (Indoor Use)

Code	Description
RMB36	<ul style="list-style-type: none"> • Double pole voltage detector • Phase relationship detector • HV fuse tester • Operating range: 5/36 kV • Total length of each rod complete with antenna: 1,17m

HIGH VOLTAGE TEST EQUIPMENT

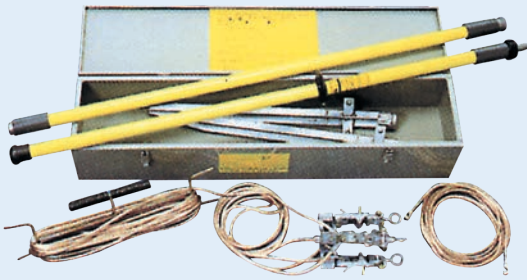

Short Circuiting and Grounding

Short circuiting and grounding equipment for electrical cabinets and MV installations with universal contact clamps

Code	Description
MT/BM-25	Standard type. Icc: 13,7kA eff / 0.25s With short circuit cables section 25mm ²
MT/BM-50	With short circuit cables section 50mm ² Icc: 13kA eff / 0.5s
MT/BM-95	With short circuit cables section 95mm ² Icc: 24kA eff / 0.5s

Certificate complies to the International Standard CEI EN 61230 (CEI IEC 1230)



Fuse Extraction Rod

Code	EF30
Description	Insulating Rod for fuse extraction and installation on systems with working voltages up to 30kV

VOLTAGE TESTERS

	Screw Driver Type		Continuity & Non-Contact	Advanced Non-Contact	Analogue	LED Bargraph Display
Code	BESTEST 7	BESTEST 18	TESTBOY20	MD-116	901	MV3
Safety Rating	—	—	Cat II 300V	Cat IV 1000V	Cat III 750V	Cat III 1000V
Test Voltage AC	200 - 250VAC	100 - 500VAC	0 - 300VAC	12V - 1000VAC	120 - 750V AC/DC	6 - 400V AC/DC
Indication	Neon	LED	Buzzer / LED	Optical, Acoustic, Vibrating	Neon / Analogue Scale	LED
Non Contact V	No	Yes	Yes	Yes	No	—
Features	<ul style="list-style-type: none"> • Contact test to earth • With pocket clip 	<ul style="list-style-type: none"> • With pocket clip • Non-contact test • Continuity check: 0 - 50MΩ • DC polarity check 1.2 - 36VDC 	<ul style="list-style-type: none"> • Non-contact voltage detector (>110VAC) • High performance LED torch • Continuity indication via lamp or buzzer • 1 pole phase detection 	<ul style="list-style-type: none"> • With pocket clip • Integrated LED flashlight • Low / high sensitivity • Three indication methods 	<ul style="list-style-type: none"> • Double insulated Handles • Neon indication of voltage presence • Clearly legible analogue scale • DC polarity indication 	<ul style="list-style-type: none"> • DC polarity indication

LED Bargraph Display

Voltage & Continuity

Code	MV-400	BESTEST 8	GK12A	MD-1060	MD-1160
Safety Rating	CAT III 600V	CAT II 500V	Cat III 1000V, Cat IV 600V	Cat IV 600V	Cat IV 600V
Test Voltage	6 - 400V AC/DC	12 - 690V AC/DC	10 - 690V AC/DC	12V - 690V AC/DC	0V - 690V AC/DC
Indication	LED	LED	LED	Acoustic / LED	Acoustic / LCD
Features	<ul style="list-style-type: none"> • DC polarity indication 	<ul style="list-style-type: none"> • Test Earth leakage CB • Continuity / Semi-conductor test 0 - 1MΩ battery powered • DC polarity indication • 1 pole phase testing 	<ul style="list-style-type: none"> • Continuity / Diode Test (<200kΩ) • Phase Rotation Test • Single pole phase testing • LED Worklight 	<ul style="list-style-type: none"> • Continuity Buzzer & LED: 0 - 500KΩ + 50% • Auto AC/DC recognition • Rotary Field Testing • Indication of extra low voltage 	<ul style="list-style-type: none"> • Continuity Buzzer & LED: 0 - 500KΩ + 50% • Auto AC/DC recognition • Rotary field testing • Indication of extra low voltage • LED Work Light • 2 pole phase sequense • Single pole phase testing

TEST EQUIPMENT







	DIY Electronic Test Kit	Magnetic Field Tester	Circuit Breaker Identifier
Code	ETK03C	AC-8M	191CBI
Features	<p>GK7 Non-contact voltage tester with LED and audio alarm; Voltage Range: 50 - 1000VAC 50 - 500Hz</p> <p>EM306B Digital Clamp Meter, Continuity Test, Diode Check, Data Hold, Voltage Range: 600V AC/DC, AC Current 20 - 400A, Resistance: 2kΩ - 200kΩ, Jaw Size: 27mm</p> <p>DT830 Digital Multimeter; Continuity Test, Diode Check Voltage range: 200mV - 250VDC / 200mV - 250VAC, Current Range: 200μA - 10ADC, Resistance: 200Ω - 2MΩ</p>	<ul style="list-style-type: none"> • Testing solenoids & relays • Illuminates when a magnetic field is present • No metallic contact required • Responds to AC and DC magnetic fields and permanent magnets 	<ul style="list-style-type: none"> • Easy tool to find a circuit breaker or fuse without disconnecting the supply • Plug the transmitter into the outlet socket, use the receiver to scan the distribution board or panel to find the correct circuit breaker supplying power to socket

CABLE TESTING/TRACING







	Wire Tracer	Multi-Purpose Wire Tester	Network Test Kit	Network Cable Tester
Code	162CB	183CB	ETK05D	KT-201
Features	<ul style="list-style-type: none"> • Trace cables within a group without damaging insulation • Volume Control • 50/60Hz filter • Auto Off function & Flashlight • Continuity Tester • Polarity Tester • LED Indication • Frequency 1kHz • c/w Batteries/Pouch 	<ul style="list-style-type: none"> • Trace cables or wires • Volume Control • Voltage free continuity and polarity testing • Tip & Ring Identification • LED Indication • Detect AC/DC Voltages • Test capacitors & diodes • Frequency: 1kHz • c/w Batteries/Pouch 	<p>5 Piece Kit includes:</p> <ul style="list-style-type: none"> • Carry case • EM415: Wire/Cable Tracer • EM416 Network Tester (RJ12 or RJ45) • BT1: Battery tester for 9V • Ratchet Crimpers • Punch Down Tool • Batteries included 	<ul style="list-style-type: none"> • Test range: 300m (L) • Accuracy: ±5% • Resolution: 0.1m • 16 x 2 LCD characters • Cable Continuity • Suitable for computer network systems • Warning: Do not use on live circuits

	UTP/STP Cable Tester	Voltage / Metal / Wood Detector	5 in 1 Detector & Distance
Code	KT-200	MVS-168A	EM60
Features	<ul style="list-style-type: none"> • Test UTP and STP wiring of T568A, T568B, 10Base-T, 100Base-T and Token ring network • Tests for open circuits, shorts, miswires, reversals, split pairs and cable's shield integrity • DEBUG mode quickly identifies which cable pairs have a specific wiring fault • Warning: do not use on live circuits • <u>Cable length specifications</u> • Min UTP/STP cable length for testing – 1m • Max UTP/STP cable length for testing – 200m 	<p><u>Detection:</u></p> <ul style="list-style-type: none"> • Stud - Wood stud 30 x 30mm: ≤10mm • Metal - Copper pipe dia.15mm: ≤24mm • AC:90 - 250VAC @ 50 - 60Hz: ≤35mm • Sensitivity can be adjusted • Can be used to accurately detect the position of pipes, AC voltage and wooden studs • Battery: 9V included 	<ul style="list-style-type: none"> • Distance Measurement: 0.4 - 18m • Accuracy: approx. 0.5% + 1 digit • Resolution: 0.01 meters • <u>Detection:</u> • Stud - Wood Stud 30 x 30mm: ≤14mm • Metal - Iron pipe dia.20mm: ≤25mm • AC: 90 - 250VAC @ 50 - 65Hz: ≤5cm • Calculates area, volume & does computation of distance • Size: 160 x 64 x 46mm • Battery: 9V incl

TEST EQUIPMENT

	Automotive Current Tester		Battery Testers		
					
Code	CF-02	CF-02S	BT-12	AT-953	BT-6
Features	<ul style="list-style-type: none"> • Measuring Range: 20A@48V AC/DC (10 Sec max) • Resolution: 10mA • Cable length: 75cm • Plugs straight into automotive fuse holder in car 		<ul style="list-style-type: none"> • 12VDC battery analyser • Voltage Test: 8 - 25VDC • On Load Battery Test (Evaluates battery's ability to crank engine) • Charging system test • Starter motor test 	<ul style="list-style-type: none"> • Battery Tester • Car lighter plug • 5 indicators: Low / Fair / Normal / Full & Over 	<ul style="list-style-type: none"> • 3in1 Battery / Bulb / Fuse Tester • To test battery types: AA, AAA, C, D, 9V, E, I, SV & PV
	CO Analyser		Coating Thickness Tester		Sound Level Calibrator
					
Code	TES-1372		TESTBOY70		SC-05
Features	<ul style="list-style-type: none"> • CO Range: 0 - 900ppm (CO) • Max hold with time stamp • Alarm level setting & replaceable sensor • Automatic zero on start-up • Accuracy $\pm 5\%$ of reading or $\pm 2\text{ppm}$ (whichever is greater) • Auto power off & back-light for display 		<ul style="list-style-type: none"> • Range: 0 - 1000μm / 0 - 40mil • c/w two probes • Measures non-magnetic coatings on steel or iron • Also measures insulating coatings on non-magnetic metals 		<ul style="list-style-type: none"> • 94db and 114db calibration at 1kHz • Accurate & simple to use • Fits 1/2inch diameter microphone • Output Frequency: 1000HZ, $\pm 4\%$ • Reference Temp: $>23^{\circ}\text{C}$ (73°F) • Relative humidity: $>35\%RH$ • Atmospheric Pressure: $>1013\text{mbar}$ (760mm of Hg) • Accuracy of sound pressure level under stated reference conditions $\pm 0.5\text{db}$

SIMULATORS & THERMOCOUPLES

	4-20mA Simulator	K & J Simulators		Bead Probe	K Type Thermocouples	
						
Code	603	601K	601J	TPK-01	TPK-03	TPK-04
Features	<ul style="list-style-type: none"> • Ideal for calibration standard & used as a current source. 	<ul style="list-style-type: none"> • Checking K type thermocouples and calibrating process indicators / controllers • Accuracy: $\pm 0.5^{\circ}\text{C}$ ($+1^{\circ}\text{F}$) 	<ul style="list-style-type: none"> • Checking J type thermocouples and calibrating process indicators / controllers • Accuracy: $\pm 0.5^{\circ}\text{C}$ ($+1^{\circ}\text{F}$) 	<ul style="list-style-type: none"> • Bead Probe • 1.2m long wire has an industry standard mini connector plug • Measure surface or air temperature 	<ul style="list-style-type: none"> • Immersion Probe • General purpose needle type with stainless sheath 	<ul style="list-style-type: none"> • Surface Probe • Ideal for measuring the surface temp. of small electronic parts. • Fast Response
Ranges	Current: 4mA, 12mA & 20mA Voltage: 9VDC	0 $^{\circ}\text{C}$ (32 $^{\circ}\text{F}$) 100 $^{\circ}\text{C}$ (212 $^{\circ}\text{F}$) 500 $^{\circ}\text{C}$ (932 $^{\circ}\text{F}$) 1000 $^{\circ}\text{C}$ (1832 $^{\circ}\text{F}$)	0 $^{\circ}\text{C}$ (32 $^{\circ}\text{F}$) 100 $^{\circ}\text{C}$ (212 $^{\circ}\text{F}$) 200 $^{\circ}\text{C}$ (392 $^{\circ}\text{F}$) 400 $^{\circ}\text{C}$ (752 $^{\circ}\text{F}$)	Temperature: 0-260 $^{\circ}\text{C}$ (500 $^{\circ}\text{F}$)	Temperature: 0-800 $^{\circ}\text{C}$ (1472 $^{\circ}\text{F}$)	Temperature: 0-800 $^{\circ}\text{C}$ (1472 $^{\circ}\text{F}$)

TEST EQUIPMENT

TEST EQUIPMENT					
	Humidity & Temp Meters	Infrared Thermometers		Pen Type Thermometers	
		Pocket size 		Temperature & Humidity 	Temperature Only 
Code	ST-612	IR-88	IR-99	ST-132	ST-133
Features	<ul style="list-style-type: none"> • Data & max hold • T1-T2 modes • Dual thermocouple input • Scan function • User selectable °C or °F 	<ul style="list-style-type: none"> • Laser targeting • Data & max hold • Auto Power Off • User selectable °C or °F 	<ul style="list-style-type: none"> • (3 in 1) IR Thermometer with Thermistor Probe and clamp • User selectable °C or °F • Data Hold and Auto Power Off • Max, Min record. 	<ul style="list-style-type: none"> • Measures temp & humidity • Min/Max Hold • Auto power off 	<ul style="list-style-type: none"> • Measures temp only • Auto power off • Display in either °C or °F • Data Hold • LCD Display
Ranges	Temperature: -50 to 1300°C K-Type Included Large Display	Temperature: -20 to 270°C Optical Resolution: 6:1 Emissivity: Fixed at 0.95% Response time: <1 sec	Temperature: IR: -35 to 260°C Optical Resolution: 1:1 Emissivity: 0.1-1 (Adj.) Probe: -40 to 260°C Clamp: -40 to 200°C Response time: <1 sec	Temperature: -30 to 50°C Humidity: 30%-95%RH	Temperature: -50 to 300°C (± 1°C / 1°F) Length: 245mm
	pH/ORP/mV Temperature Meter	pH Meter Kit	Pen Type pH Tester	Moisture Meter	
	IP57  ORP Probe to be ordered separately	 ORP Probe to be ordered separately		Complete Kit 	
Code	7011	MP-103	PP201	PH5011A	EM4807
Features	<ul style="list-style-type: none"> • Large LCD Display • Rugged Design • Floats on Water • Max/Min/Data Hold 	<ul style="list-style-type: none"> • Large LCD Display • Splash Proof Housing & Magnet for Handsfree Operation • Auto or Manual Temperature Compensation • Auto Power Off 	<ul style="list-style-type: none"> • Large LCD Display • Rugged Design • Auto Power Off 	<ul style="list-style-type: none"> • Fast Response • High Accuracy • Splash Proof • Extendable Electrode: 90mm 	<ul style="list-style-type: none"> • Measure moisture level in paper/cardboard, wood & hardened material (mortar/concrete/plaster). • Measure ambient temp. • Built in torch.
Ranges	ORP Range: -1000 - 1000mV PH Range: 0 - 16 ATC Range: 0 - 90°C Calibration pH: 4.00, 7.00, 10.01 Temp Range: 0 - 90°C (°C / °F)	ORP Range: ± 1999mV PH Range: 0 - 14 ATC Range: 0 - 100°C Calibration pH: 4.00, 7.00, 10.00 Temp Range: 0 - 100°C (°C / °F)	PH Range: 0 - 14 ATC Range: 0 - 100°C Calibration pH: 4.00, 7.00, 10.00	PH Range: 0 - 14 ATC Range: 0 - 100°C	Wood: 6-42% Resolution: 1% Building Material: 0.2-2% Temperature: 0-40°C/ 32-99°F
Accessories	PH Probe: 7000EP4 ORP Probe: 7000EO Buffer Solution 4.00 (50cc): B-4 Buffer Solution 7.00 (50cc): B-7	ORP Probe: MP-103-ORP Buffer Solution 4.00 (50cc): B-4 Buffer Solution 7.00 (50cc): B-7	Buffer Solution 4.00 (50cc): B-4 Buffer Solution 7.00 (50cc): B-7	Buffer Solution 4.00 (50cc): B-4 Buffer Solution 7.00 (50cc): B-7	-

NEW **THERMAL IMAGING CAMERAS**

Compact Range - Thermal Imaging Cameras for your Smart Phone

Made for iPhone® and Android™ top models, Seek Compact transforms your smartphone or tablet into a professional thermal imaging tool. By utilizing the power and convenience of your smartphone, our cameras make it easy to take thermal photos and video, share findings, and send for documentation. Simply connect and detect energy loss caused by air leaks, missing or damaged insulation, inefficient HVAC systems, electrical faults, and much more. On top of all this, Seek Compact cameras are engineered to run on low power from your smartphone and do not require batteries or charging.

	Compact Thermal Camera	CompactXR Thermal Camera	CompactPRO Thermal Camera
Android™ Code	ST-COMPACT-A	ST-COMPACTXR-A	ST-COMPACTPRO-A
iPhone® Code	ST-COMPACT-I	ST-COMPACTXR-I	ST-COMPACTPRO-I
Features	<ul style="list-style-type: none"> • Easy to Use Indoor Versatility. Wide field of view quickly scans the inside of any room • High-Performance Thermal Sensor accurately identifies areas of heat loss and gain • Best in Class Temperature Range • Customize, Record and Share Intuitive, free mobile app available on Google Play and iTunes App Store • Focusable Lens for Quick Identification • Comes with its own waterproof case 	<ul style="list-style-type: none"> • Built for Long-Range Detection. Narrow field of view quickly scans up to 550 meters • High-Performance Thermal Sensor accurately identifies heat signatures • Best-in-Class Temperature Range • Customize, Record and Share Intuitive, free mobile app available on Google Play and iTunes App Store • Focusable Lens for Quick Identification • Comes with its own waterproof case 	<ul style="list-style-type: none"> • High-Resolution Thermal Sensor 76,800 temperature pixels for maximum image clarity and sensitivity • Adjustable Emissivity. Calibrate for reflective surfaces when accuracy is critical • Span & Level: Isolate and capture the thermal details that matter • Wide, 32-Degree Field of View Easily scan a large area to identify potential hazards in seconds • Focusable Lens for Quick Identification • Utilizes the Power and Display of Your Smartphone. Intuitive, free mobile app available on Google Play and iTunes App Store • Comes with its own waterproof case
Specifications			
Thermal Sensor	206 x 156	206 x 156	320 x 240
Detection Distance	300 Meters	550 Meters	550 Meters
Field of View	36°	20°	32°
Temperature Range	-40°C to 330°C	-40°C to 330°C	-40°C to 330°C
Frame Rate	<9Hz	<9Hz	<15Hz FastFrame
Temp. Display Scale	Fahrenheit or Celsius	Fahrenheit or Celsius	Fahrenheit or Celsius or Kelvin
Colour Palettes	9 Options	9 Options	9 Options
Consumption	Up to 280mW	Up to 280mW	Up to 280mW

Accessories



Code	Description
ST-BLAKE-CLIP	1/4" threaded tripod mounting bracket for Seek Compact range
ST-COMP-CABLE	USB cable for connection of Seek Compact range to PC

TEST INSTRUMENTS, TOOLS & GENSETS

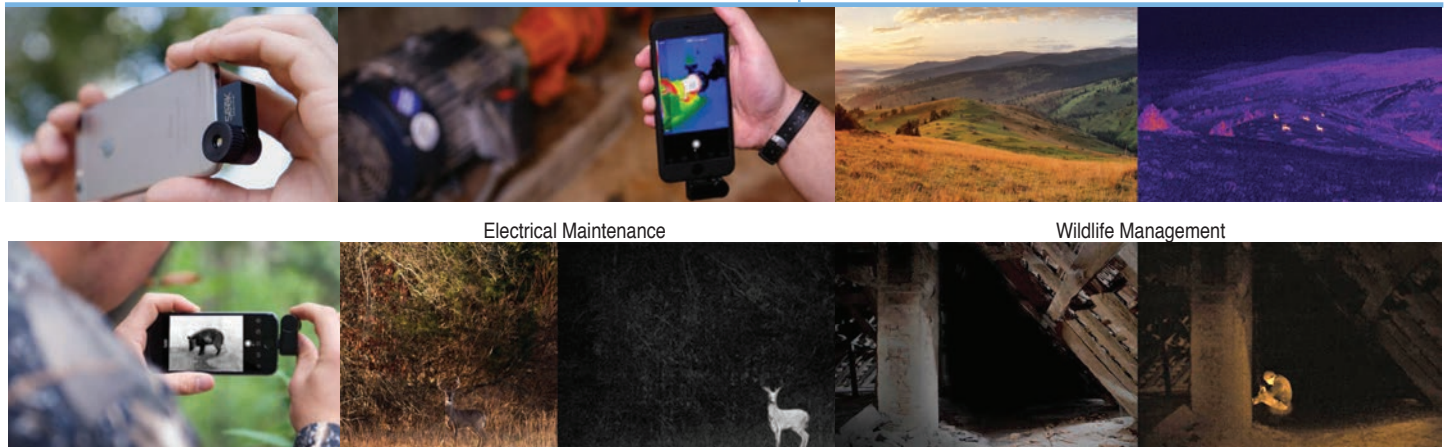

Electrical Maintenance

Wildlife Management

Hunting Applications

Security or Rescue Applications

NEW THERMAL IMAGING CAMERAS

Powerful and rugged in design, the standalone Seek Reveal combines high-resolution thermal imaging, a long-lasting rechargeable battery, and a large color display in one durable device. And when you need it, Reveal's powerful 300-lumen LED light is available at the touch of a button. Seek Shot is the most advanced thermal imaging camera for building professionals. Snap photo and video and analyze immediately with new on-board thermography tools. Add spot measurements and temperature boxes to create time-saving reports on the spot. Take full control of photos and video by adjusting the blend between visible and thermal images. Share and stream to any smartphone or tablet over WiFi.

	Reveal Thermal Imager	RevealPRO Thermal Imager	Shot Range IP54	
				
Code	ST-REVEAL	ST-REVEAL XR*	ST-SHOTPRO	
Features	<ul style="list-style-type: none"> • Wide field of view quickly scans the inside of any room • Best-in-Class Temperature Range • Up to 10hrs of continuous thermal imaging on a single charge • Intuitive Software. Continuous feature enhancements 	<ul style="list-style-type: none"> * Add B for Black or C for Camo • Built for Long-Range Detection • High-Performance Thermal Sensor • Best-in-Class Temperature Range • Up to 10 hours of continuous thermal imaging on a single charge • Intuitive Software • Continuous feature enhancements 	<ul style="list-style-type: none"> • High-Resolution Thermal Sensor • Rugged, rubberized casing with Corning® Gorilla® Glass • Continuous Digital Zoom up to 4X • Up to 4 hours of thermal imaging in Normal MODE • Level and span controls let you isolate and capture the details that matter • Adjustable Emissivity. Calibrate for reflective surfaces when accuracy is critical 	<ul style="list-style-type: none"> • More pixels, more precision - more resolution than the competition. Best in class thermal resolution • SeekFusion™ Technology - See exactly what you're looking at with combined visible thermal images • Large colour touch Screen - 3.5" with 640x480 resolution • Stream a live thermal view onto your smartphone or tablet via WiFi • Up to 4hrs contin. thermal imaging • 3 Customizable spot temperatures • 3 Customizable area boxes • Adjustable span & emissivity
Specifications				
Thermal Sensor	206 x 156	206 x 156	320 x 240	
Detection Distance	150 Meters	275 Meters	550 Meters	
Field of View	36°	36°	32°	
Temperature Range	-40°C to 330°C	-40°C to 330°C	-40°C to 330°C	
Frame Rate	<9Hz	9Hz	>15 Hz FastFrame in Normal MODE	
Flashlight	300 Lumen LED	300 Lumen LED	300 Lumen LED	
Temp. Display Scale	Fahrenheit or Celsius	Fahrenheit or Celsius	Fahrenheit, Celsius or Kelvin	
Colour Palettes	7 Options	7 Options	9 Options	
Storage Media	MicroSD Card Included	MicroSD Card Included	4GB Internal Drive	



ST-VELCRO-1



ST-DRING-1

Accessories

Code	Description
ST-VELCRO-1	Holster Bag with Velcro for Seek Reveal range
ST-DRING-1	Attach your Seek Reveal D-Ring to any retractable lanyard (not incl.)



Security Surveillance

Industrial Surveillance

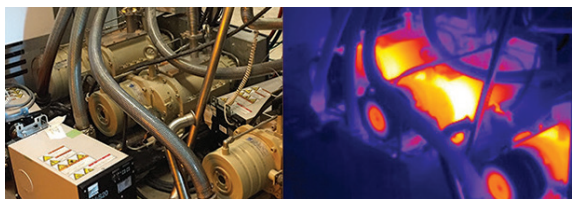

Failing Pumps/Motors



Thermal Image, Corroded Fuse

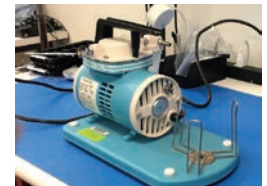

Visible Image

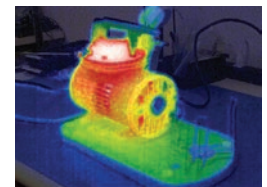

SeekFusion™ Image

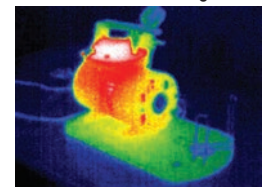

Thermal Image

DISPLAY UNITS & CABINETS

These Display Units are available on placing of Stock Orders worth a minimum Rand Value.
Please contact the MET Brand Manager for more details.

			
			Desk Top Display
Code	AC/DC DISPLAY CABINET	AC/DC DISPLAY CABINET-1	AC/DC DISPLAY CABINET-2
Description	Choice of 3 variations: 1. Hand tools and meters 2. Power tools 3. Combination of 1 & 2	Large display cabinet containing a selection of Mastech products	Small display cabinet containing a selection of Mastech products
Size	1200(W) x 440(D) x 2000(H)	600(W) x 380(D) x 1800(H)	600(W) x 380(D) x 800(H)

LASER LEVELS & LINE GENERATORS





				
Code	LD-SL08	LD-LS10	LD-LS12	LD-LS15
Description	Self levelling laser	Three laser line generator	Laser line generator	Mini laser level
Accuracy	0.5mm per meter	± 1mm per meter	± 2mm per meter	± 2mm per meter
Features	<ul style="list-style-type: none"> Adjustable base Lock system with on/off switch 635nm laser generator 	<ul style="list-style-type: none"> Self leveling 3 Directional beams 	<ul style="list-style-type: none"> Ultra compact Vertical & horizontal level 	<ul style="list-style-type: none"> Magnetic base with mini tripod
			Laser Spirit Levels (with horizontal laser beam/cross line)	
				
			LS8-1	LS7
			Standard	Electronic Inductive
				
Code	LD-SC2	LD-SL01	LD-LS05JD	LD-LS03S
Description	Rotary laser	Self levelling laser	Angle finder with laser	Laser level with magnetic base
Accuracy	± 5mm per 10 meter	± 1mm per meter	± 1mm per meter	± 2mm per meter
Features	<ul style="list-style-type: none"> Auto Rotating beam Portable, suitable for construction sites. Power: 6VDC 	<ul style="list-style-type: none"> Professional tripod c/w carry case Power: 3VDC 	<ul style="list-style-type: none"> Analogue angle finder Includes carry bag 	<ul style="list-style-type: none"> Lightweight magnetic base Vertical and horizontal



NEW





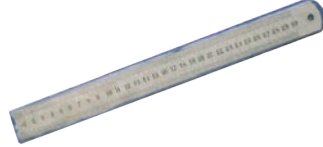
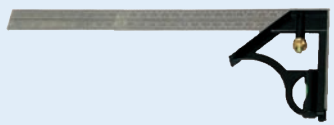

SPIRIT LEVELS

Torpedo Level	Spirit Levels - 3 Vial			Post Level
				
LD-S93B Length - 225mm	LD-2007-2B-600 Length - 600mm	LD-2007-2B-1000 Length - 1000mm	LD-2007-2B-1200 Length - 1200mm	F7708LS6 Size: 125 x 75mm





MEASURING EQUIPMENT

Standard Measuring Tapes		Digital Measuring Tape		Fibre Glass Measuring Tapes	
					
LD-10NO7X 10 meter Auto-rolling steel tape	TM-3M 3 meter Auto-rolling steel tape	TM-5M 5 meter Auto-rolling steel tape	LD-SX501E Digital display - 5 meter Memory and backlight Dual system measurement (metric/imperial)	TM-20M 20 meter Manual rolling	TM-50M 50 meter Manual rolling
	JC-306 30 meter Manual rolling	JC-506 50 meter Manual rolling			

Try & Mitre Square		General Purpose T Square		Stainless Steel Rulers		Combination Square 300mm
						
F7501KH441 150mm	F7502KH442 200mm	F4569GPTS6 600mm	F4570GPTS10 1000mm	ARK-167103-12 12" / 300mm	ARK-167103-20 20" / 500mm	SB205562 Adjustable Square with spirit level

Digital Vernier	Digital Outside Micrometer	O-Ring & Scriber Set	Dividers	Chalk Line	
					
SB168101-8 0 - 200mm - Large Display	SB168163-1 0 - 25mm	SS-4-KIT Scriber, Hook and Picker	YG-100 100mm Dividers	SB256713 30m / 100"	SB0765010 Blue Colour Chalk Powder

MAGNIFYING GLASSES

				
Code	ZD-10D	TLE-1099	TLE-1094	TLE-1104
	<ul style="list-style-type: none"> Magnifying Glass with holding spring clips (x2) Can be locked at a specific angle 	<ul style="list-style-type: none"> Ø: 90mm With illumination Works on 2x1.5V AA batteries (not included) 	<ul style="list-style-type: none"> Power: 230VAC, 22W (T5) Size of lens: 5" Diopter/power: 5 Diopter Colour: White 	<ul style="list-style-type: none"> Head Magnifying Glass Power: 1.8X, 2.3X, 3.7X, 4.8X

TOOL KITS 1000V

	1000V 10 Pc Electrician Tool Set + Carry Bag (VDE)	1000V 12 Pc Electrician Tool Set + Carry Bag (VDE)	1000V 31 Pc Electricians Back Pack (VDE)
		 Multimeter not included	
Code	V10-010	V10-012	BT-032
Description	<ul style="list-style-type: none"> • 5Pcs Electricians Screwdriver VDE 1000V: <ul style="list-style-type: none"> - PH0 x 60, PH1 x 80, PH2 x 100 - Slotted 4 x 100mm, 6.5 x 150mm • 1Pc Long Nose Plier 150mm VDE 1000V • 1Pc Side Cutter 150mm VDE 1000V • 1Pc Wire Stripper 150mm VDE 1000V • 1 Roll Insulation Tape 10m • 1Pc Voltage Tester / Screw Driver 140mm 	<ul style="list-style-type: none"> • 5Pcs Electricians Screwdriver VDE 1000V: <ul style="list-style-type: none"> - PH0 x 60, PH1 x 80, PH2 x 100 - Slotted 4 x 100mm, 5.5 x 125mm • 1Pc Long Nose Plier 150mm VDE 1000V • 1Pc Side Cutter 150mm VDE 1000V • 1Pc Wire Stripper 150mm VDE 1000V • 1Pc Stripping Tool 200mm • 1Pc 7 LED Head light • 1 Roll Insulation Tape 10m • 1Pc Voltage Tester / Screw Driver • Carry Bag 400 x 230 x 285mm 	<ul style="list-style-type: none"> • 150mm Cable Cutter VDE 1000V • 160mm Wire Stripper VDE 1000V • 160mm Long Nose Pliers VDE 1000V • 200mm Combination Plier VDE 1000V • 180mm HD Side Cutter VDE 1000V • 7Pc Screwdriver Set VDE 1000V • 250mm Groove Joint Plier VDE 1000V • 7Pcs Allen Key Set • 300mm Groove Joint Plier • 220mm HD uninsulated crimper • Headlight 7 x White LED 3/stage • SW8 Socket Wrench Screwdriver • 200mm Insulated Shifting Spanner • WAK2 Utility Knife • 5Mtr Measuring Tape • 250mm Vice Grips • 150mm Mini Hacksaw • 300mm BP Ball peen Hammer

	Belt Pouch	Equipped Imitation Leather Case	Equipped Resin Case	13pc Screwdriver Set
<i>intercable</i>				
Code	19142 (Kit) 19140 (Empty Case)	19231 (Kit) 19230 (Empty Case)	19172 (Kit) 19170 (Empty Case)	SB0607243
Size	200 x 100 x 200mm	360 x 290 x 75mm	430 x 340 x 160mm	
Equipped with	Screwdriver for slotted head screws Futur II 0.5 x 3 x 100mm (1301030) Futur II 0.8 x 4 x 100mm (1301040) Futur II 1.2 x 6.5 x 150mm (1301065) Screwdriver for Philips screws "Philips" Futur II PH 1 x 75 (13021) "Philips" Futur II PH 2 x 100 (13022) Engineers pliers 190mm (AP0119N) Cable cutter 160mm (AP1017) Special electricians scissors (16011) Voltage tester (AV6104) Power disc cable puller (AV8902)	Engineers pliers 190mm (AP0119N) Long Nose pliers c/w straight jaws (AP0416N) Screwdriver for slotted head screws Futur II 0.5 x 3 x 100mm (1301030) Futur II 0.8 x 4 x 100mm (1301040) Futur II 1.2 x 6.5 x 150mm (1301065) Screwdriver for Philips screws "Philips" Futur II PH 1 x 75 (13021) "Philips" Futur II PH 2 x 100 (13022) "Pozidriv" Futur II PZ 1 x 75 (13031) "Pozidriv" Futur II Pz 2 x 100 (13032) Cable knife (AV3920) Insulated scissors (AV6720) Cable cutter 160mm (AP1017)	Engineers pliers 190mm (AP0119N) Long Nose pliers c/w straight jaws (AP0416N) Screwdriver for slotted head screws Futur II 0.5 x 3 x 100mm (1301030) Futur II 0.8 x 4 x 100mm (1301040) Futur II 1 x 5.5 x 125mm (1301055) Futur II 1.2 x 6.5 x 150mm (1301065) Screwdriver for Philips screws "Philips" Futur II PH 1 x 75 (13021) "Philips" Futur II PH 2 x 100 (13022) Cable cutter 160mm (AP1017) Special electricians scissors (16011) Power disc cable puller (AV8902) Panel Key (AV9310)	All in one driver set with clip on handle • 4 Piece Slotted Screwdrivers: - 1.2 x 6.5 x 100mm - 1 x 5.5 x 100mm - 0.8 x 4 x 100mm - 0.5 x 3 x 100mm • 2 x Phillips Screwdrivers: - PH2 x 100mm - PH1 x 80mm • 2 x Pozidrive Screwdrivers: - PZ2 x 100mm - PZ1 x 80mm • 1 x Single Pole Voltage Tester • 1 x Clip-on Screwdriver handle

NEW

TOOLS

Soft Back-Pack/Trolley - 14pcs

Code BM1815 without Tools
Code BM1815A1 with Tools



- **Screwdrivers:**
 - 1) Flat VDE Insul. 3 x 100mm
 - 2) Flat VDE Insul. 4 x 100mm
 - 3) Flat VDE Insul. 5,5 x 125mm
 - 4) Flat VDE Insul. 6,5 x 150mm
 - 5) Phillips VDE Insul. PH0 x 60mm
 - 6) Phillips VDE Insul. PH1 x 80mm
 - 7) Phillips VDE Insul. PH2 x 100mm
- Voltage Tester Flat 3 x 60mm 250V
- Combination Plier VDE Insul. 180mm
- Engineers Hammer
- Pocket Saw
- Cutter Stripper Scissor + Box
- Measuring Tape 3m x 16mm
- Pocket Spirit Level 220mm

Belt Bag - 5pcs



Kit Code:
BM18030M1

Bag Code:
BM18030

Code BM18030M1
Code BM18030 (pouch only)

- **Screwdrivers:**
 - 1) FLAT 3 x 100mm
 - 2) FLAT 4 x 100mm
 - 3) PHILLIPS PH1 x 80mm
- Combination Pliers 180mm
- Stainless Steel Shears (**BM1310**)

Tool Back-Pack - 11pcs

Code BM18122



- **Screwdrivers:**
 - 1) FLAT 3 x 100mm
 - 2) FLAT 4 x 100mm
 - 3) FLAT 5.5 x 125mm
 - 4) PHILLIPS PH1 x 80mm
 - 5) POZI PZ1 x 80mm
- Combination Pliers 160mm
- Stainless Steel Shears (**BM1310**)
- Side Cutter 140mm
- Voltage Tester
- Measuring Tape 3m
- Universal Knife

Tool Case with Wheels 72pcs

Code	BM18403 (Kit)	BM18400 (Case Only)
• VDE insulated bi-component tools	• Screwdrivers: 2. x 75	• Long Nose Plier: 200mm
• Screwdrivers: 4 x 100	5.5 x 125	• Flat Nose Plier: 160mm
6.5 x 150	8 x 175	• Water Pump Plier: 250mm
PH0 x 60	PH1 x 80	• Crimping Tool: isol 0.25 - 6mm ²
PZ2 x 100	PZ3 x 150	• Retaining Screwdriver: 4 x 125/PH1x150
• Nut Drivers: 10-13	• Combination Plier: 160mm	• Voltage Tester: 220V-250 V, 3.5 x 100
• Side Cutter: 160mm	• Side Cutter: 160mm	• Stainless Steel Scissors
		• Cable Shear: 35mm ²
		• Pocket Saw
		• Cable Stripping Knife: 8 - 28mm
		• Universal Knife
		• Automatic Stripping Tool: 0.5 - 4mm ²
		• Measuring Tape: 3m
		• Rewinding Cord Marker (Chalk line)
		• Blue Chalk: 250g
		• Aluminium Spirit Level: 220mm
		• Adjustable Wrench
		• Allen Wrench Set: 9pcs
		• Panel Key
		• Double Ended wrench Set: 8pcs
		• Hammer: 300g
		• Chisel: 250g
		• Puncher Chisel: 250mm
		• HSS and Masonary Drill Set 19pcs

Tool Case with Wheels 167pcs

Code	TK3167
Trolley Box 485 x 365 x 195mm	1 x Screwdriver bit holder
1 x Hack Saw 300mm	6 x Precision screwdriver
3 x Saw blades	1 x Tester 200-250V, CE
1 x Level 400mm	1 x Try square 250mm
3 x Carpenter's pencil	1 x 3-Way Adaptor
1 x Half round steel file 200mm	1 x 1/2" Universal joint
1 x Callipers 10mm	1 x 1/4" Dr. Extension Bar 75mm
1 x Combination Plier 180mm	1 x 1/4" Dr. Sliding Bar
1 x Long Nose Plier 150mm	1 x 1/4" Bit Adaptor
1 x Water Pump Plier 250mm	1 x Screwdriver handle 1/4"
1 x Crimping Tool	7 x Spanner: 8-10-12-13-14-17-19mm
30 x Terminals in Plastic Box	1 x Machinist's hammer 300g
1 x Knife 18mm	1 x Measuring Tape 3m
10 x Blades 18mm	
	9 x Hex Key: 1.5-2-2.5-3-4-5-6-8-10mm
	9 x Torx set: T10-15-20-25-27-30-40-45-50
	2 x Screwdriver slotted: 6x38, 6x100mm
	3 x Screwdriver phillips: PH2x38, PH1x75, PH2x100mm
	1 x Screwdriver phillips: PH2x100mm, VDE 1000V
	1 x Screwdriver slotted: 5x100mm, VDE 1000V
	1 x Adjustable Wrench, max working open distance 29mm
	12 x 1/2" Dr. Socket: 10-11-12-13-14-15-17-18-19-20-22-24
	2 x 1/2" Dr. Extension Bar 125&250mm
	2 x 1/2" Spark Plug Socket 16&21mm
	2 x 1/2" Dr. 72 Teeth Quick Release Ratchet Handle.
	12 x 1/4" Dr. Socket: 4-4.5-5-5.5-6-7-8-9-10-11-12-13mm
	1 x 1/4" Dr. 72 Teeth Quick Release Ratchet Handle.
	32 x Bit Set with Quick Chuck Bit Holder

TOOL KITS



SB210120

39 Pieces



SB210123

48 Pieces



Tool Kit with spotlight and red/amber blinking light c/w car plug. Uses 4 x size 'C' batteries (not included)

PL-8985

13 Pieces



SB210112

63 Pieces



SB003017

10 Pieces



Kit Includes:
• RJ11/45 Crimping Tool
• RJ11, 12, 45 connectors
• Network cable tester
• Cable stripper
• Impact insertion tool

ZD-922B

Telecoms Tool Kit

ELECTRONIC TOOL KITS

Nylon Tool Bag				
Code	ZD-963	ZD-902	ZD-906	ZD-907

MECHANICAL TOOLBOX

85 Piece Kit in 5 Tray Cantilever Box

Code TOOT2631



- 1 x 1/2" Sliding T Bar
- **18 pc 1/2" Sockets :**
8, 10, 11, 12, 13, 14, 15, 16, 17, 18, 19, 20, 21, 22, 24, 27, 30, 32mm
- 1pc Universal Joint 1/2"
- 1pc Extension bar 125mm
- 1pc 1/2" H handle
- 1pc Ratchet 1/2"
- **7 Pc Combination Screwdriver:**
Slotted: 3.2x75mm, 4x100mm, 6x100mm, 8x150mm
- **Phillips:**
PH1x75mm, PH2x100mm, PH3x150mm
- **12 Pc Combination Spanner:**
8,10,11,12,13,14,15,16, 17,18,19,22mm
- 1 x 10" Water Pump Pliers
- 1 x 10" Vice Grip
- 1 x Tape Measure 5m x 19mm
- 1 x Combination Plier 180mm
- 1 x Side Cutter 160mm
- 1 x Long Nose Plier 160mm
- 2 x Spark Plug Sockets:16,21mm
- 1 x Trimming Knife + 5 Pc Blades
- **1 x 9Pc Allen Key Set :**
1.5, 2, 2.5, 3, 4, 5, 6, 8, 10mm
- **1 x 9Pc Torx Key Set:**
T10, 15, 20, 25, 27, 30, 40, 45, 50
- **10pc BITS:**
SL3, SL4, SL5, PZ1, PZ2, PH1, PH2, PH3, T10, T15 + Handle

1000V TOOL KITS

Wera Zyklop VDE Ratchet Set with 3/8" drive

Individually tested as per IEC60900 at 10,000V for safe working at the approved voltage of 1000V

- Slim design to enable work in confined spaces.
- Fine tooth mechanism with 80 teeth for a return angle of only 45°.
- The ball lock ensures sockets and accessories are securely fitted, providing increased safety during operation.
- A short press on the release button allows the tool to be changed quickly.



VDE Socket Set c/w Ratchet

Code	Description
5004970001	17Pcs 3/8" VDE Insulated Ratchet Set: - 1 x Ratchet - 1 x Short Extension - 1 x Long Extension - Sockets: 6, 7, 8, 9, 10, 11, 12, 13, 14, 15, 16, 17, 18, 19

Insulated Reversible Ratchet

5004966001	3/8" x 222mm Ratchet
------------	----------------------

Insulated Long Extension

5004965001	3/8" x 166mm
------------	--------------

Insulated Short Extension

5004964001	3/8" x 91mm
------------	-------------

Individual VDE Insulated Sockets

Code	Description
5004950001	6mm x 46mm 3/8" Socket
5004951001	7mm x 46mm 3/8" Socket
5004952001	8mm x 46mm 3/8" Socket
5004953001	9mm x 46mm 3/8" Socket
5004954001	10mm x 46mm 3/8" Socket
5004955001	11mm x 46mm 3/8" Socket
5004956001	12mm x 46mm 3/8" Socket
5004957001	13mm x 46mm 3/8" Socket
5004958001	14mm x 46mm 3/8" Socket
5004959001	15mm x 46mm 3/8" Socket
5004960001	16mm x 46mm 3/8" Socket
5004961001	17mm x 46mm 3/8" Socket
5004962001	18mm x 46mm 3/8" Socket
5004963001	19mm x 46mm 3/8" Socket



HAND TOOLS

Click-Torque B 2 Torque Wrench with Reversible Ratchet

Code 5075611001



Design: With 3/8" square drive, reversible ratchet, 45 teeth, easy setting and saving of the desired torque value, with audible and tactile locking when the scale values are reached (fine scale only in Newton meters), audible and tactile release mechanism when the set torque value is reached.

Handle: Ergonomic 2-component handle.

Application: For clockwise torque-control.

Precision: ± 3% of set value, as per DIN, EN, ISO 6789-1: 2017-07.

	Nm	Nm	lbf.ft.	mm	mm	mm	mm	mm	mm	mm	mm	mm	mm	mm	mm
1/4"	2.5-25	0,10	1-18	290	121	42	25	11,5	11 27/64"	4 49/64"	1 23/32"	1"	7/16"		

NEW

HAND TOOLS

Tool - Check Plus	BlackLaser Multicolour L-Key Set Metric	Kraftform Kompakt VDE 60i
<p>813 Handle 1/4" Adapter 889/4/1 K Universal Bit Holder 8001A Mini Ratchet</p>		<p>VDE TOOL KRAFTFORM ERGONOMICS ANTI ROLL-OFF EXTRA SLIM</p>
W-TC-PLUS/37	W-950SPKL/9	W-KK-VDE/16
<ul style="list-style-type: none"> 8790 HMA Sockets 1 x 5.5, 1 x 6.0, 1 x 7.0, 1 x 8.0, 1 x 10.0, 1 x 12.0, 1 x 13.0 851/1 TZ PH : 2 x PH1, 3 x PH2, 1 x PH3 855/1 TZ PZ : 1 x PZ1, 3 x PZ2, 1 x PZ3 867/1 TZ Torx: 1 x Tx10, 1 x Tx15, 1 x Tx20, 1 x T25, 1 x Tx30, 1 x Tx40 867/1 TZ Torx BO: 1 x Tx10, 1 x Tx15, 1 x Tx20, 1 x T25, 1 x Tx30 840/1 Z HexPlus: 1 x 3.0, 1 x 4.0, 1 x 5.0, 1 x 6.0, 1 x 8.0 800/1 TZ Slotted: 1 x 1.0 x 5.5 	<p>Colour coded sleeves for easy recognition, HEX-Plus, Ball-end Hexagon on Long arm.</p> <ul style="list-style-type: none"> 1 x 1.5 x 90 1 x 2.0 x 101 1 x 2.5 x 112 1 x 3.0 x 123 1 x 4.0 x 137 1 x 5.0 x 154 1 x 6.0 x 172 1 x 8.0 x 195 1 x 10.0 x 224 	<p>16pc set in Folding Textile Pouch Interchangeable Blades 154mm long</p> <ul style="list-style-type: none"> 1 x PH1, 1 x PH2 1 x PZ1, 1 x PZ2 1 x PZ/S1, PZ/S2 1 x TX10, 1 x TX15, 1 x TX20, 1 x TX25 1 x 0.4 x 2.5, 1 x 0.6 x 3.5, 1 x 0.8 x 4.0, 1 x 1.0 x 5.5 1 x 0.5 x 3.0 x 70 Voltage Tester

Kraftform 6Pcs Set	Kraftform Classic 6Pcs Set	Kraftform 9Pcs Set	Kraftform Classic 9Pcs Set
W-10001/6	W-1734/6	W-10009/9	W-1734/9
<ul style="list-style-type: none"> ELS 1 x 0.60 x 3.5 x 75 ELS 1 x 0.80 x 4.0 x 100 MS 1 x 1.20 x 6.50 x 125 MS 1 x 1.20 x 8.00 x 150 PH No.1 x 80 PH No.2 x 100 	<ul style="list-style-type: none"> ELS 1 x 0.60 x 3.5 x 75 ELS 1 x 0.80 x 4.0 x 100 MS 1 x 1.20 x 6.50 x 125 MS 1 x 1.20 x 8.00 x 150 PH No.1 x 80 PH No.2 x 100 	<ul style="list-style-type: none"> ELS 1 x 0.60 x 3.5 x 75 ELS 1 x 0.80 x 4.0 x 100 ELS 1 x 1.00 x 5.5 x 150 ELS 1 x 1.00 x 5.5 x 40 MS 1 x 1.20 x 6.50 x 125 MS 1 x 1.20 x 8.00 x 150 MS 1 x 1.60 x 8.00 x 150 PH No.1 x 80 PH No.2 x 100 	<ul style="list-style-type: none"> ELS 1 x 0.60 x 3.5 x 75 ELS 1 x 0.80 x 4.0 x 100 ELS 1 x 1.00 x 5.5 x 150 ELS 1 x 1.00 x 5.5 x 40 MS 1 x 1.20 x 6.50 x 125 MS 1 x 1.20 x 8.00 x 150 MS 1 x 1.60 x 8.00 x 150 PH No.1 x 80 PH No.2 x 100

Kraftform 11Pcs Set	VDE Kraftform Comfort 7Pcs Set	Kraftform Plus 395 Hollow Shaft Nutdriver	
<p>For TORX Screws</p>	<p>c/w Voltage Tester</p>	<p>For Hexagon Bolts, Screws & Nuts. Allows for screws with Long Thread.</p> <p>HOLLOW SHAFT</p>	
W-6334/11	W-1160i/7	Code	Nut/Screw Size
<ul style="list-style-type: none"> 1 x T6 1 x T7 1 x T8 1 x T9 1 x T10 1 x T15 1 x T20 1 x T25 1 x T27 1 x T30 1 x T40 	<ul style="list-style-type: none"> ELS 1 x 0.4 x 2.50 x 80 ELS 1 x 0.60 x 3.5 x 100 ELS 1 x 0.80 x 4.0 x 100 ELS 1 x 1.00 x 5.5 x 125 ELS 1 x 1.20 x 6.5 x 150 ELS 1 x 1.60 x 8.00 x 200 PZ No.1 x 80 PZ No.2 x 100 	<ul style="list-style-type: none"> W-395-HO-5.5 W-395-HO-7 W-395-HO-8 W-395-HO-10 W-395-HO-13 	<ul style="list-style-type: none"> 5.5mm 7mm 8mm 10mm 13mm 70mm 80mm 80mm 80mm 90mm 98mm 105mm 105mm 105mm 112mm

HAND TOOLS 1000V

Slotted Electrical Screwdrivers 1000V (VDE)

Code	mm	mm	mm	Code	mm	mm	mm
VJF-258-1	2.5	80	160	VJF-258-5	6.5	150	258
VJF-258-2	3.5	75	155	VJF-258-6	3.0	100	197
VJF-258-3	4.0	100	197	VJF-258-7	8.0	150	267
VJF-258-4	5.5	125	233	VJF-258-8	8.0	200	317

Philips Electrical Screwdrivers 1000V (VDE)

Code	size	mm	mm	Code	size	mm	mm
VJF-258-9	0	75	155	VJF-258-12	2	100	197
VJF-258-10	1	80	177	VJF-258-13	3	150	258
VJF-258-11	1	100	197				

Pozidrive Electrical Screwdrivers 1000V (VDE)

Code	size	mm	mm	Code	size	mm	mm
VJF-258-14	0	75	155	VJF-258-17	2	100	197
VJF-258-15	1	80	177	VJF-258-18	3	150	258
VJF-258-16	1	100	197				



Insulated Screwdriver Sets 1000V (VDE)

12 Piece VDE Tool Set

Code	mm	mm	mm	size	mm	mm
V10-4005	3.5	75	155	0	75	155
	4.0	100	197	1	80	177
	5.5	125	233	2	100	197

Kit Includes

- VDE Wire Stripper
- VDE Long Nose pliers
- VDE diagonal Cutter
- VDE Combination Pliers (150mm each)

Screwdriver - Includes Testing Function 100-250VAC. c/w 2 x Testers, 100-250VAC



VFL-2105



VFL-2234

6 Piece Kit

Code	mm	size	mm	mm
VFL-2105	2.5		75	140
	3.5		75	160
	4		100	200
	5.5		125	236
		1	80	180
		2	100	200

Screwdriver - Includes Testing Function 100-250VAC c/w 1 x Tester, 100-250VAC, 140mm

8 Piece Kit

Code	mm	size	mm	mm
VFL-2234	3.5		75	160
	4		100	200
	5.5		125	236
	6.5		150	258
		0	75	160
		1	80	180
		2	100	200

Screwdriver - Includes Testing Function 100-250VAC c/w 1 x Tester, 100-250VAC, 140mm

	Combination Pliers	Long Nose Pliers	Bent Nose Pliers	Side Cutters	
<ul style="list-style-type: none"> • 1000V VDE • Chrome Vanadium Steel • Micro Finish • Bi-material TPR Handle 					
Code (150mm) 6"	V10-2105	V10-2108	V10-2113	V10-2110	
Code (180mm) 7"	V10-2106	-	-	V10-2115	
Code (200mm) 8"	V10-2107	V10-2109	V10-2114	-	
	Wire Stripper	Roundnose Pliers	Flatnose Pliers	Waterpump Pliers	Insulated Linesman Pliers
Code (150mm) 6"	V10-2112	V10-2118	V10-2117	-	1000V - with integrated crimper
Code (250mm) 9"	-	-	-	V10-2116	10-2207 (250mm)

1000V INSULATED TOOLS



Cable Cutter with Ratchet

Description	Cable Size Ømm mm ²	Code	Length mm
<ul style="list-style-type: none"> For copper and aluminium cables only Special blades with high cutting capacity With opening device 	32 240	1604032	250
	52 380	1607054	380
	22 80	1602200	200



Universal-knife with Interchangeable Blade

<ul style="list-style-type: none"> With ordinary blade made of shock-proof material 	AV3910	200
Spare blade for AV3910	AV3911	-



Cable-knife with Blade Protection (For Cable Stripping)

<ul style="list-style-type: none"> With solid blade and insulated blade-back Special blade cuts insulation, not copper made of shock-proof material 	AV3920	200
Spare blade for AV3920	AV3921	-



Scissors

<ul style="list-style-type: none"> Surface treatment: Burnished Protected Handles of shock-proof plastic 	AV6720	180
--	---------------	-----



Set - Cable-stripping Tool (AMS)

Kit Includes: 1 Cable-stripping-tool (AV6220) 1 Cable knife (AV3920) 1 Spare blade (AV3921)	AS1003	240 x 260 height
---	---------------	------------------



Retaining Screwdrivers for Slotted Head Screws

Description	Code	⌀ mm	mm	⌀ mm	mm
<ul style="list-style-type: none"> Blade of tempered, high-alloyed steel (surface: browned) 	AC1451	3.0	100	0.5	190
	AC1452	4.0	125	0.7	225
	AC1453	5.0	150	0.8	285



Retaining Screwdrivers for Phillips Screws

Description	Code	⊕ No.	mm	mm
<ul style="list-style-type: none"> Blade of tempered, high-alloyed steel (surface: browned) 	AC1750	0	125	225
	AC1751	1	150	260
	AC1752	2	175	285



Screwdrivers for Hexagon Screws

Description	Code	⬡ mm	mm	mm
<ul style="list-style-type: none"> Blade of tempered, high-alloyed steel (surface: browned) With power handle 	1306040	4	125	215
	1306050	5	125	215
	1306060	6	125	215
	1306080	8	125	225
	1306100	10	125	225
	1306130	13	125	225
	UNI 6750 DIN 7445			



Single Ended Spanner

<ul style="list-style-type: none"> Quality symbol VDE/GS only for sizes 10-24mm Spanner inclination: 15° Tempered, alloyed steel 	AC2006	6	-	105
	AC2008	8	-	105
	AC2010	10	-	105
	AC2013	13	-	132
UNI 6733 DIN 7446				



FIXED BLADE CABLE KNIVES

Code	Description
31HS	• Fixed Straight Blade Wire Stripper
32HS	• Fixed Hook Blade - No damage on conductor cores
33HS	• Fixed Hook Blade - Suitable for sector cables

HAND TOOLS



Hammers & Mallets



Claw Hammer	Ball Hammer	Rubber Mallet
		
566gram SB203016	440gram SB203162-16 672gram SB203162-24	440gram SB203541-16 672gram SB203541-24
Fully polished with plastic coated handle	Fully polished with plastic handle	With fibreglass handle



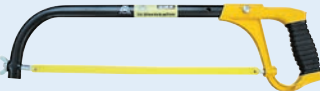

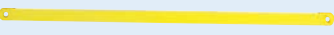
Two Way Mallet	Stone Hammer	Cold Chisels		
				
35mm Ø SB203591-35 45mm Ø SB203591-45	1kg ARK-146301-1 2kg ARK-146301-2	B15013 13 x 150mm	B25025 25 x 150mm	ARK-255213 19 x 250mm, with Hand Protector
With fibreglass handle	Drop forged			

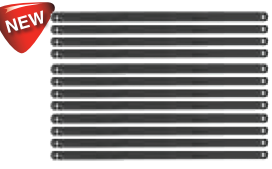
Wrecking Bar	Tommy Bar	Center Punch	Punch Sets
			
B450WB 450 x 19mm B600WB 600 x 19mm	B450TB 450 x 19mm B600TB 600 x 19mm	3210030K 3 x 120mm 3210050K 5 x 120mm	YT-6855 9pcs, Numbers YT-6863 27pcs, Letters
			8mm

Tubular Hacksaws

3Pc File Set	Oval Tubular Hacksaw Frame	Square Tubular Hacksaw Frame	Spare Hacksaw Blades
			
SB208863 200mm (8") flat, round, half round	SB208101 With aluminium handle 250-300mm	SB208172 With aluminium handle and soft grip 300mm (12")	SB208311 12 Pieces 300mm (12")

Junior Hacksaw	Spare Junior Hacksaw Blades	Cable Tie Tensioners	
			
ARK-243111-6 All Aluminium 6"	TOOH860 12 Pieces 6" Blades	HS-600A Cable Tie Gun for tensioning and auto cutting for ties 2.5-4.8mm	TG-100 Cable Tie Gun for tensioning and manual cutting for ties 2.5-4.8mm

Suction Lifters			Plastic Tape Dispenser	Silicon/Caulking Gun												
		<table border="1"> <thead> <tr> <th>Code</th> <th>Description</th> <th>Carrying Capacity</th> </tr> </thead> <tbody> <tr> <td>BM1760</td> <td>1 Cup suction disc</td> <td>30kg</td> </tr> <tr> <td>BM1770</td> <td>2 Cup suction discs</td> <td>60kg</td> </tr> <tr> <td>BM1761</td> <td>Spare suction disc</td> <td>—</td> </tr> </tbody> </table>	Code	Description	Carrying Capacity	BM1760	1 Cup suction disc	30kg	BM1770	2 Cup suction discs	60kg	BM1761	Spare suction disc	—		
Code	Description	Carrying Capacity														
BM1760	1 Cup suction disc	30kg														
BM1770	2 Cup suction discs	60kg														
BM1761	Spare suction disc	—														
BM1760	BM1770	Cup Size: 120mm Ø	HL5041 For use with packaging tape	SB257803 Rubber grip to prevent slipping												

UTILITY KNIVES & SETS

Heavy Duty Blades	Folding Knife	Utility Knife	3pc Utility Knife Set	Snap-off Knife	Snap-off Blades
F4030TK1B/H5 (5Pcs) F4036TK1B/H20 (20Pcs) F4031TK1B/H100 (100Pcs) Made in Sheffield England	F4004TK7 With Belt Clip & Blade Included	SB215009 Zinc Alloy, 3 Blades in Handle, Retractable SB215152 (10Pc) Spare Blades	SB215162 Large Snap-off Knife, Small Snap-off Knife, Heavy Duty Utility Knife	F4001TK5 (18mm) SB215120 (9mm) Adjustable Utility Knife with Snap off Blades	F7748TK6B (18mm) SB215153 (9mm) Spare Blades

HAND TOOLS

	Shifting Spanners	Water Pump (Gas) Pliers	Vice Grip (Curved Jaw)
Code (125mm) 5"	-	-	HT10-4026
Code (180mm) 7"	-	-	HT10-4027
Code (200mm) 8"	HT12-1062	HT10-5531	-
Code (254mm) 10"	HT12-1063	HT10-5532	HT10-4028
Code (300mm) 12"	HT12-1064	HT10-5534	-

Mini Pliers • Bi-Material TPR Handle (soft rubber)

	Electronic Side Cutter	Long Nose	Bent Nose	Flat Nose	Round Nose
Code	HT10-3069	HT10-3061	HT10-3062	HT10-3063	HT10-3064
Desc.	130mm	128mm	128mm	115mm	101mm
	Diagonal Cut	End Cut	Linesman	Needle Nose	
Code	HT10-3065	HT10-3066	HT10-3067	HT10-3068	
Desc.	101mm	101mm	115mm	153mm	

HAND TOOLS

Spanners • Material: Chrome Vanadium Steel

Combination Spanner				Double Open Ended Spanner			
Size mm	Code	Size mm	Code	Size mm	Code	Size mm	Code
6	HT12-4206	19	HT12-4219	6 – 7	HT12-6206	20 – 22	HT12-6220
7	HT12-4207	20	HT12-4220	8 – 9	HT12-6208	21 – 23	HT12-6221
8	HT12-4208	21	HT12-4221	10 – 11	HT12-6210	22 – 24	HT12-6222
9	HT12-4209	22	HT12-4222	12 – 13	HT12-6212	25 – 28	HT12-6225
10	HT12-4210	23	HT12-4223	14 – 15	HT12-6214	27 – 29	HT12-6227
11	HT12-4211	24	HT12-4224	16 – 17	HT12-6216	30 – 32	HT12-6230
12	HT12-4212	25	HT12-4225	18 – 19	HT12-6218		
13	HT12-4213	26	HT12-4226	Pipe Wrench 9" Code SB137803-9		Screwdriver Bit HSB-PH2/5MM 1/4"x PH2x50mm	
14	HT12-4214	27	HT12-4227				
15	HT12-4215	28	HT12-4228				
16	HT12-4216	29	HT12-4229				
17	HT12-4217	30	HT12-4230				
18	HT12-4218	32	HT12-4232				

Spanner & Allen (Hex) Key Sets

8pc Aluminium Frame Folding Tool		30Pc		9Pc		Ball Point	
Metric Type 1.5, 2, 2.5, 3, 4, 5, 6, 8 	Torx T9, T10, T15, T20, T25, T27, T30, T40 	0.028-3/8", 0.7-10mm Flat End 		1.5-10mm, Chrome Plated 		9 pieces 1.5 - 10mm 	
FLH-0057	FLH-0056	SB202403		SB202407		SB233157	

Ratchet Combination Wrench		9Pc Ratchet Wrench Set		9Pc Spanner Set		6Pc Spanner Set		7Pc Spanner Set	
Code	Size mm	Code	SB133249	SB202102		SB202106		TSS-7-8/19	
 SB133211-8 8 SB133211-10 10 SB133211-13 13 SB133211-15 15 SB133211-17 17 SB133211-19 19 72 Tooth ratchet needs only 5° of movement to turn a fastener		 72 Tooth ratchet needs only 5° of movement to turn a fastener 8, 10, 11, 12, 13, 14, 16, 17, 19mm		9Pc Combination Spanner Set 7, 8, 10, 11, 12, 13, 16, 17, 19mm 		6Pc Double Open Ended Spanner Set 6+7, 8+9, 10+11, 12+13, 14+15, 16+17mm 		7Pc Piece Tube Spanner Set 8x9 10x11 12x13, 14x15, 16x17, 18x19mm 	

47pcs Ratchet/Driver Set		Metric Socket Wrench Kit		Screwdriver Kits		31 Piece Screwdriver Bit Set		Nutdriver Kit - 7 Pieces	
 88-0041 • 36 Tooth Palm Handle c/w extra grip ring • Compact, convenient bit/Socket holder • Ergonomic anti-slip rubber grip • Carbon Steel Bits & Sockets (CRV)	 22MRA-CV-S Kit Includes: • 16pcs 1/2" Dr. Sockets: 10-19, 21-24, 27, 30, 32mm • 2Pcs 1/2" Dr. extensions 3" x 5" • 1Pcs 1/2" Dr. x 3/8" Adapter • 1Pcs 1/2" Dr. Universal joint • 1Pcs 1/2" Dr. (F) Ratchet handle	 SB156237 16 Piece precision screwdriver set	 CT-2016 Screw driver set	 SB157243 Phillips, Flat, Torx and Hex	 SB154115 Sizes: 5, 6, 8, 10, 11, 12, 13 Length: 245mm				

TEST INSTRUMENTS, TOOLS & GENSETS

HAND RIVETERS



HR705

HR702

HR710

HR720

- High grade aluminium die cast housing with drop-forged carbon steel upper handle.
- Steel and jaw case are made of chromed, hardened steel plate.

- Carbon steel forged housing and handle with powder coated surface.
- Jaw and jaw case are made of chromed, heat treated steel.
- Designed for industrial use.

- Lever design reduces physical strength for all rivet sizes.
- The three-jaw design can provide better performance with only a change of nose nozzle.

Code	Length (mm)	Rivet Setting Capacity
HR705	265	Up to 4.8mm (3/16") for all materials
HR702	255	Up to 4.0mm (5/32") for all materials and 4.8mm (3/16") for aluminium
HR710	300 Closed/810 Open	Up to 6.4mm (1/4") for all materials
HR720	430	Up to 4.8mm (3/16") for all materials

BLIND RIVETS

Aluminium Rivets with Steel

Mandrels

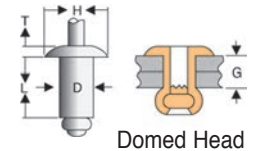
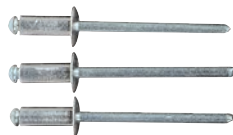

Domed Head

Code	Length	Grip Range	Diameter	Hole Size (mm)	Head Dia	Head Thickness	Standard Strength N. (min.)	
	L	G			H	T	Shear	Tensile
AS3.2-8-*	8	3-5	3.2mm	3.3-3.4mm	5.8-6.5	1.2	535	650
AS3.2-10-*	10	5-7						
AS3.2-12-*	12	7-9						
AS4-6-*	6	1.5-2.5	4.0mm	4.1-4.2mm	7.0-8.0	1.5	850	1020
AS4-8-*	8	2.5-4.5						
AS4-10-*	10	4.5-6.5						
AS4-12-*	12	6.5-8.5						
AS4-14-†	14	8.5-10.5	4.8mm	4.9-5.0mm	8.5-9.5	1.6	1160	1420
AS4-18-†	18	12.5-14.5						
AS4.8-10-†	10	4-6						
AS4.8-12-†	12	6-8						
AS4.8-14-†	14	8-10						
AS4.8-18-†	18	12-14						

Add quantity to code: * 1000 (box packed), 100 (packed in polybag for retail). † 500 (box packed), 100 (packed in polybag for retail).

DIN RAIL CUTTER

	Guillotine	Dies		Support Guide	
Code	BM2691	BM269112	BM269113	BM26912	BM269122
	Cutter & puncher for rails EN 50035, EN 50022, EN 50045. Designed for extremely rapid, precise and safe cutting & punching of standardised metal frame profiles.	For rail DIN35(DR35) 7.5mm	For rail DIN35(NS35/15) 15mm	Support Guide for BM2691	Support Guide for rail 7.5 & 15mm

SOLDERING IRONS

Soldering Irons			Solder Spools																																									
		<table border="1"> <thead> <tr> <th>Code</th> <th>Description</th> <th>Spare Tips</th> </tr> </thead> <tbody> <tr> <td>Z88-2026</td> <td>30W mains Soldering Iron</td> <td>Z79-2120</td> </tr> <tr> <td>Z88-2028</td> <td>50W mains Soldering Iron</td> <td>Z79-2320</td> </tr> <tr> <td>ZD-715L-100W</td> <td>100W mains Soldering Iron</td> <td>Z79-8504</td> </tr> <tr> <td>ZD-715L-200W</td> <td>200W mains Soldering Iron</td> <td>Z79-8506</td> </tr> <tr> <td>Z89-2934</td> <td>48W station type Soldering Iron 160°C-480°C digital Spare Element Z79-201B</td> <td>Z79-1146 Z79-1156</td> </tr> <tr> <td>Z89-2926</td> <td>48W station type Soldering Iron 150°C-420°C Spare Element Z79-201B</td> <td>Z79-1146 Z79-1156</td> </tr> <tr> <td>Z78-201B</td> <td>Spare Heater Element for Iron Z89-2934 & Z89-2926</td> <td>-</td> </tr> <tr> <td>Z88-201B</td> <td>Spare Iron for Z89-2934 & Z89-2926</td> <td>-</td> </tr> </tbody> </table>	Code	Description	Spare Tips	Z88-2026	30W mains Soldering Iron	Z79-2120	Z88-2028	50W mains Soldering Iron	Z79-2320	ZD-715L-100W	100W mains Soldering Iron	Z79-8504	ZD-715L-200W	200W mains Soldering Iron	Z79-8506	Z89-2934	48W station type Soldering Iron 160°C-480°C digital Spare Element Z79-201B	Z79-1146 Z79-1156	Z89-2926	48W station type Soldering Iron 150°C-420°C Spare Element Z79-201B	Z79-1146 Z79-1156	Z78-201B	Spare Heater Element for Iron Z89-2934 & Z89-2926	-	Z88-201B	Spare Iron for Z89-2934 & Z89-2926	-	<table border="1"> <thead> <tr> <th>Code</th> <th>Description</th> </tr> </thead> <tbody> <tr> <td>SN60% PB40%</td> <td></td> </tr> <tr> <td>500g rolls</td> <td></td> </tr> <tr> <td>SSA08500</td> <td>Ø0.7mm</td> </tr> <tr> <td>SSA10500</td> <td>Ø0.90mm</td> </tr> <tr> <td>SSA12500</td> <td>Ø1.25mm</td> </tr> <tr> <td>SSA20000</td> <td>Ø2.0mm</td> </tr> </tbody> </table>	Code	Description	SN60% PB40%		500g rolls		SSA08500	Ø0.7mm	SSA10500	Ø0.90mm	SSA12500	Ø1.25mm	SSA20000	Ø2.0mm
Code	Description	Spare Tips																																										
Z88-2026	30W mains Soldering Iron	Z79-2120																																										
Z88-2028	50W mains Soldering Iron	Z79-2320																																										
ZD-715L-100W	100W mains Soldering Iron	Z79-8504																																										
ZD-715L-200W	200W mains Soldering Iron	Z79-8506																																										
Z89-2934	48W station type Soldering Iron 160°C-480°C digital Spare Element Z79-201B	Z79-1146 Z79-1156																																										
Z89-2926	48W station type Soldering Iron 150°C-420°C Spare Element Z79-201B	Z79-1146 Z79-1156																																										
Z78-201B	Spare Heater Element for Iron Z89-2934 & Z89-2926	-																																										
Z88-201B	Spare Iron for Z89-2934 & Z89-2926	-																																										
Code	Description																																											
SN60% PB40%																																												
500g rolls																																												
SSA08500	Ø0.7mm																																											
SSA10500	Ø0.90mm																																											
SSA12500	Ø1.25mm																																											
SSA20000	Ø2.0mm																																											

			<p>Solder pot lead free Adjustable Temp: 200-600°C</p>	<p>Solder pot lead free Adjustable Temp: 200-600°C</p>																								
<table border="1"> <thead> <tr> <th>Code</th> <th>Description</th> </tr> </thead> <tbody> <tr> <td>SH-827</td> <td>Solder Sucker</td> </tr> <tr> <td>T-1</td> <td>Spare Tip</td> </tr> </tbody> </table>	Code	Description	SH-827	Solder Sucker	T-1	Spare Tip	<table border="1"> <thead> <tr> <th>Code</th> <th>Description</th> </tr> </thead> <tbody> <tr> <td>SH-814B</td> <td>50W Soldering Iron stand</td> </tr> </tbody> </table>	Code	Description	SH-814B	50W Soldering Iron stand	<table border="1"> <thead> <tr> <th>Code</th> <th>Description</th> </tr> </thead> <tbody> <tr> <td>SH-60</td> <td>50W Electric Solder Sucker</td> </tr> <tr> <td>SH-60H</td> <td>Spare element</td> </tr> </tbody> </table>	Code	Description	SH-60	50W Electric Solder Sucker	SH-60H	Spare element	<table border="1"> <thead> <tr> <th>Code</th> <th>Description</th> </tr> </thead> <tbody> <tr> <td>TAURUS-107</td> <td>Power: 500W Pot dimensions: 100 x 70 x 45mm Capacity: 2.3kg</td> </tr> </tbody> </table>	Code	Description	TAURUS-107	Power: 500W Pot dimensions: 100 x 70 x 45mm Capacity: 2.3kg	<table border="1"> <thead> <tr> <th>Code</th> <th>Description</th> </tr> </thead> <tbody> <tr> <td>TAURUS-558</td> <td>Power: 250W Pot dimensions: 55 x 55 x 45mm Capacity 1.2kg</td> </tr> </tbody> </table>	Code	Description	TAURUS-558	Power: 250W Pot dimensions: 55 x 55 x 45mm Capacity 1.2kg
Code	Description																											
SH-827	Solder Sucker																											
T-1	Spare Tip																											
Code	Description																											
SH-814B	50W Soldering Iron stand																											
Code	Description																											
SH-60	50W Electric Solder Sucker																											
SH-60H	Spare element																											
Code	Description																											
TAURUS-107	Power: 500W Pot dimensions: 100 x 70 x 45mm Capacity: 2.3kg																											
Code	Description																											
TAURUS-558	Power: 250W Pot dimensions: 55 x 55 x 45mm Capacity 1.2kg																											

GAS POWERED HEAT TOOLS

All models use Butane gas						
Code	ES-720TH	ES-720SI	ES-650SI	ES-720KB	ES-650KB	
Weight	170g	170g	162g (No Gas)	Kit includes:	Kit Includes:	
Gas Capacity	19ml	19ml	15ml	• ES-720 multi function soldering iron	• ES-650SI 3-In 1 Butan Powered Soldering Iron	
Operating Time	90min	90min	45-60min	• 2.4mm Conical tip	200-400°C (Soldering Iron)	
Temperature	Up to 1300°C	Up to 480°C	200-400°C (Soldering Iron) Up to 450°C (Heat Gun) Up to 1,300°C (Torch)	• 2.4mm Chisel tip	Up to 450°C (Heat Gun) Up to 1,300°C (Torch)	
Features	Portable heavy-duty torch Meets U.S. child resistant standard	Portable multi-function soldering iron/heat tool	3 in 1 Butan Powered Tool	• Hot knife tip	• 2.4mm Chisel Tip	
Size	180 x 52 x 111mm	180 x 52 x 157mm	250 x 30 x 25mm	• Deflector tip	• Hot Knife Tip	
				• Sponge	• Mini Wrench	
				• Soldering wire	• Deflector Tip	
				• Wrench	• Sponge Set	
Accessories	Code	Description	Code	Description	Code	Description
	L-016	Conical 1.6mm	L-132	Chisel 3.2mm	L-310	Hot knife
	L-024	Conical 2.4mm	L-1105	Chisel 10.5mm	L-311	Hot knife
	L-124	Chisel 2.4mm	L-230	Diagonal 3.0mm	L-510	Heat blower
			A-BR	Burning room	L-610	Heat deflector

Accessories included with ES-720KB

CABLE & WIRE STRIPPING TOOLS

					
Code	STRIP-2 2-level stripping of all coaxial cables of 4.8 - 7.5mm outer Ø Performance Range: Coaxial 4.8 - 7.5mm Ø Cabtyre 4 x 0.75mm ² Flexible cables 1.5mm ² - 16mm ²	As per STRIP-2 with built-in side cutter	This tool allows circular and horizontal stripping and needs no adjustment of cutting depth. Range: Flex Cables: 4 - 13mm Ø. Solid Conductors: 0.5 - 6mm ² . Multi-level of coaxial cables: 4 to 8 mm Ø. Built in side-cutter.		
		 FLAT	 ROUND		
Code	STRIP-5 <ul style="list-style-type: none"> Automatic wire stripper for all common stranded and solid conductors of 0.2 - 6.0 mm² Adjustable length stop of 5 - 12mm (removable if required) Easily accessible built-in side cutter for max 2mm Ø 	STRIP-7-FLAT Flat Cables: Cable and wire stripping of two or three core flat cables with PVC insulation from 0.75mm ² to 4.0mm. Round Cables: Cable and wire stripping of flexible cables in a range of 0.5mm ² to 16.0mm ² . Solid conductors from 0.5mm ² to 10mm ² . Spare Blade: STRIP7-BLADE (Round)	STRIP-7	STRIP-300 (Duo - strip/crimp) Three tools in one: Wire Stripper for inner insulations from 0.5 - 6mm ² ; Crimping of bootlace terminals with two crimping ranges: 0.75mm ² - 1.5mm ² and 2.5mm ² - 6.0mm ² as well as built-in side cutter for max. 6.0mm ²	
					 Spare Blade STRIP4-BLADE
Code	STRIP-SOLAR MINI <ul style="list-style-type: none"> Stripping depth stop Compact wire stripper designed for the solar industry Suits 1.5-Ø6mm Side blade cutter 	STRIP-7-SOLAR An automatic wire stripper for all common round cables used in solar engineering. Precise adjustment allows easy removal of multiple insulation layers of solar cables from 1,5-6mm ² .	STRIP4-28H Both circular and longitudinal cuts are possible due to a self-turning stripping blade. Accurate, fast and safe stripping of all common round cables of 4 - 28mmØ.	STRIP-428V Same as STRIP4-28H , plus: Cable connections, sockets, fuses, circuitry, connecting boxes, lamps and fairy lights etc. can be safely tested for AC voltage by an integral electric potential field sensor. No current flow is required.	STRIP-428 Same as STRIP4-28H , plus: This is the first cable stripper of its kind which has an additional hook blade that can be retracted into the tool & be fixed in both positions.
 <ul style="list-style-type: none"> Cable stripper for accurate fast and safe stripping of common round cables 4 - 28mmØ. Variable adjustment of cutting depth with adjusting wheel with no damage to the inner conductors Automatic adjustment for circular or longitudinal cuts through turnable blade Additional function: stripping of conductors for all common flexible and solid conductors 0,5mm² - 6.0mm² 	 <ul style="list-style-type: none"> 12 Piece retail counter display stand c/w 12 pieces of STRIP-S428-M 	 Round Cable Stripper For all round cables of 8 - 13mm (e.g. 3 x 1.5mm ² up to 5 x 2.5mm ²) Stripper For all common stranded and solid conductors of 0.5mm ² to 6.0mm ² Coax Stripper Two- or three-level stripping of all common coaxial cables for 4.8 to 7.5 mm outer Ø. Built in side cutter For PVC-insulated round cables of max 9mm ²			 Second bit inside the handle Voltage tester 110 - 250V Two turnable bits 1.PZ1⊗ 3.5 x 0.6mm [⊗] 2.PZ2⊗ 4.0 x 0.8mm [⊗]
Code	STRIP-S428-M	STRIP-S428/12-M	STRIP-500		

CABLE & WIRE STRIPPING TOOLS

Professional Cable Stripping Starter Kit

Code	PRO-STARTER
All standard cable types can easily be stripped and dismantled using the tools in the kit	
STRIP-428: The cable stripper allows precise, quick and safe stripping of all standard round cables with a diameter between 4 and 28 millimeters. Comes with retractable hook blade.	
STRIP-5: Automatic Wire Stripper. Precise work with adjustable length stop (5 - 12mm). Side cutter up to 2mm diameter.	
STRIP-13: For all standard round cables diameter 8 - 13mm. Flush stripping, even in hard to reach places.	
STRIP-2: Two-level stripping of all common coaxial cables.	

SB201422	SB201426	SB201009	LY-700A	LY-700D
Wire Stripper for cables 0.5-4mm ²	Wire Stripper for cables 6-16mm ² 0.75-6mm ²	For wire 0.5-6.0mm ²	For wire 0.5-2.0mm ²	For wire 0.5-6.0mm ²
			LY-700B	
			For wire 1.0-3.2mm ²	

CRIMPING TOOL KITS

	<table border="1" style="width: 100%; border-collapse: collapse;"> <tr> <th style="width: 15%;">Code</th> <th style="width: 85%;">YS-03C0-1A</th> </tr> <tr> <td colspan="2">For boot-lace insulated ferrules 300pcs (0.5-4.0mm²) c/w Tool type YS-03C0</td> </tr> </table>	Code	YS-03C0-1A	For boot-lace insulated ferrules 300pcs (0.5-4.0mm ²) c/w Tool type YS-03C0			<table border="1" style="width: 100%; border-collapse: collapse;"> <tr> <th style="width: 15%;">Code</th> <th style="width: 85%;">HT-914A</th> </tr> <tr> <td colspan="2">Data Socket Insertion Tool For data socket use on 66 & 110/88 type connectors</td> </tr> </table>	Code	HT-914A	Data Socket Insertion Tool For data socket use on 66 & 110/88 type connectors	
Code	YS-03C0-1A										
For boot-lace insulated ferrules 300pcs (0.5-4.0mm ²) c/w Tool type YS-03C0											
Code	HT-914A										
Data Socket Insertion Tool For data socket use on 66 & 110/88 type connectors											
	<table border="1" style="width: 100%; border-collapse: collapse;"> <tr> <th style="width: 15%;">Code</th> <th style="width: 85%;">Y-190</th> </tr> <tr> <td colspan="2">151pcs Mixed Insulated Lugs c/w Tool type KH-502</td> </tr> </table>	Code	Y-190	151pcs Mixed Insulated Lugs c/w Tool type KH-502			<table border="1" style="width: 100%; border-collapse: collapse;"> <tr> <th style="width: 15%;">Code</th> <th style="width: 85%;">KH-502</th> </tr> <tr> <td colspan="2">Multipurpose Tool</td> </tr> </table>	Code	KH-502	Multipurpose Tool	
Code	Y-190										
151pcs Mixed Insulated Lugs c/w Tool type KH-502											
Code	KH-502										
Multipurpose Tool											
	<table border="1" style="width: 100%; border-collapse: collapse;"> <tr> <th style="width: 15%;">Code</th> <th style="width: 85%;">Y-202</th> </tr> <tr> <td colspan="2">120pcs Mixed Insulated Lugs</td> </tr> </table>	Code	Y-202	120pcs Mixed Insulated Lugs			<table border="1" style="width: 100%; border-collapse: collapse;"> <tr> <th style="width: 15%;">Code</th> <th style="width: 85%;">SB201437</th> </tr> <tr> <td colspan="2">45pcs Mixed Insulated Lugs c/w Terminal Crimp and Wire Stripper</td> </tr> </table>	Code	SB201437	45pcs Mixed Insulated Lugs c/w Terminal Crimp and Wire Stripper	
Code	Y-202										
120pcs Mixed Insulated Lugs											
Code	SB201437										
45pcs Mixed Insulated Lugs c/w Terminal Crimp and Wire Stripper											
	<table border="1" style="width: 100%; border-collapse: collapse;"> <tr> <th style="width: 15%;">Code</th> <th style="width: 85%;">Y-200</th> </tr> <tr> <td colspan="2">300pcs Mixed Insulated Lugs</td> </tr> </table>	Code	Y-200	300pcs Mixed Insulated Lugs							
Code	Y-200										
300pcs Mixed Insulated Lugs											

BOOT LACE / LUG KITS

<p>Kit for Insulated Lugs</p>	<p>Kit for Boot-Lace Ferrules</p>														
<table border="1" style="width: 100%; border-collapse: collapse;"> <tr> <th style="width: 15%;">Code</th> <th style="width: 85%;">BM00411</th> </tr> <tr> <td colspan="2">Kit Includes Tool: BM534</td> </tr> <tr> <td style="width: 50%;">Red 1.5mm² Insulated : 4mm Ring - 100pcs; 4mm fork - 100pcs; 5mm Ring - 100pcs; 10mm Pin - 100pcs; Ferrules - 100pcs; 6.3mm female disc. - 100pcs; 6.3mm male disc. - 100pcs</td> <td style="width: 50%;">Blue 2.5mm² Insulated: 4mm Ring - 100pcs; 4mm fork - 100pcs; 5mm Ring - 100pcs; 10mm Pin - 100pcs; Ferrules - 100pcs; 6.3mm female disc. - 100pcs; 6.3mm male disc. - 100pcs; 6.3mm insulated female disc. - 50pcs</td> </tr> <tr> <td colspan="2">Yellow 4-6mm² 5mm Ring - 50pcs; Ferrules - 50pcs; 6mm Ring - 50pcs</td> </tr> </table>	Code	BM00411	Kit Includes Tool: BM534		Red 1.5mm² Insulated : 4mm Ring - 100pcs; 4mm fork - 100pcs; 5mm Ring - 100pcs; 10mm Pin - 100pcs; Ferrules - 100pcs; 6.3mm female disc. - 100pcs; 6.3mm male disc. - 100pcs	Blue 2.5mm² Insulated: 4mm Ring - 100pcs; 4mm fork - 100pcs; 5mm Ring - 100pcs; 10mm Pin - 100pcs; Ferrules - 100pcs; 6.3mm female disc. - 100pcs; 6.3mm male disc. - 100pcs; 6.3mm insulated female disc. - 50pcs	Yellow 4-6mm² 5mm Ring - 50pcs; Ferrules - 50pcs; 6mm Ring - 50pcs		<table border="1" style="width: 100%; border-collapse: collapse;"> <tr> <th style="width: 15%;">Code</th> <th style="width: 85%;">BM00412</th> </tr> <tr> <td colspan="2">Kit Includes Tool: BM541</td> </tr> <tr> <td style="width: 50%;">Bootlace Ferrules Single: 0.75mm² white 500pcs; 1mm² yellow 500pcs; 1.5mm² red 500pcs; 2.5mm² blue 250pcs; 4mm² grey 200pcs; 6mm² black 100pcs; 10mm² ivory 50pcs; 16mm² green 50pcs</td> <td style="width: 50%;">Bootlace Ferrules Double: 2 x 0.75mm² white 200pcs; 2 x 1mm² yellow 200pcs; 2 x 1.5mm² red 200pcs; 2 x 2.5mm² blue 100pcs; 2 x 4mm² grey 100pcs; 2 x 6mm² green 50pcs</td> </tr> </table>	Code	BM00412	Kit Includes Tool: BM541		Bootlace Ferrules Single: 0.75mm ² white 500pcs; 1mm ² yellow 500pcs; 1.5mm ² red 500pcs; 2.5mm ² blue 250pcs; 4mm ² grey 200pcs; 6mm ² black 100pcs; 10mm ² ivory 50pcs; 16mm ² green 50pcs	Bootlace Ferrules Double: 2 x 0.75mm ² white 200pcs; 2 x 1mm ² yellow 200pcs; 2 x 1.5mm ² red 200pcs; 2 x 2.5mm ² blue 100pcs; 2 x 4mm ² grey 100pcs; 2 x 6mm ² green 50pcs
Code	BM00411														
Kit Includes Tool: BM534															
Red 1.5mm² Insulated : 4mm Ring - 100pcs; 4mm fork - 100pcs; 5mm Ring - 100pcs; 10mm Pin - 100pcs; Ferrules - 100pcs; 6.3mm female disc. - 100pcs; 6.3mm male disc. - 100pcs	Blue 2.5mm² Insulated: 4mm Ring - 100pcs; 4mm fork - 100pcs; 5mm Ring - 100pcs; 10mm Pin - 100pcs; Ferrules - 100pcs; 6.3mm female disc. - 100pcs; 6.3mm male disc. - 100pcs; 6.3mm insulated female disc. - 50pcs														
Yellow 4-6mm² 5mm Ring - 50pcs; Ferrules - 50pcs; 6mm Ring - 50pcs															
Code	BM00412														
Kit Includes Tool: BM541															
Bootlace Ferrules Single: 0.75mm ² white 500pcs; 1mm ² yellow 500pcs; 1.5mm ² red 500pcs; 2.5mm ² blue 250pcs; 4mm ² grey 200pcs; 6mm ² black 100pcs; 10mm ² ivory 50pcs; 16mm ² green 50pcs	Bootlace Ferrules Double: 2 x 0.75mm ² white 200pcs; 2 x 1mm ² yellow 200pcs; 2 x 1.5mm ² red 200pcs; 2 x 2.5mm ² blue 100pcs; 2 x 4mm ² grey 100pcs; 2 x 6mm ² green 50pcs														

CRIMPING TOOLS

	Professional Tools Code BM Type	Description	Economy Tools Code
	BM534	For insulated lugs (red, blue, yellow)	LY-03C
	BM537 (0.5-4.0mm ²)	For insulated boot-lace ferrules	LY-04WF (0.5-6.0mm ²)
	BM539	For insulated boot-lace ferrules (6-16mm ²) For insulated boot-lace ferrules (10-35mm ²)	LY-16WF LY-35WF
	BM531	For non insulated auto lugs (0.5-6mm ²)	LY-03B
	BM535 (0.5 - 10mm ²)	For non insulated lugs	KH-16 (1.25-16mm ²) KH-22 (5.5-25mm ²)
	-	Hex hand crimp for non insulated lugs	HX-16 (6-16mm ²) HX-26B (6-25mm ²) HS-05H (1.5-25mm ²)
	BM543	For coaxial connectors for cable RG58-59-62-6	HS-02H
	BM53816 (0.08 - 16mm ²)	For insulated boot-lace ferrules	HSC8-6-4 (0.25 - 6mm ²) HSC8-6-6 (0.25 - 6mm ²) HSC8-16-4 (4 - 16mm ²)
	BM549	Crimping tool for RJ11, RJ12, RJ45	ZD-501006

	Code	Description		Code	Description
	BM524	Uninsulated Terminals 0.5-10mm ²		BM523	Heavy Duty crimping Tool for use with uninsulated terminals 10-120mm ²
	BM525	Uninsulated Terminals 2.5-16mm ²			
	BM526	Uninsulated Terminals 6-35mm ²			
	BM527	Bootlace Terminals 25 - 35 - 50mm ²			

Hand Crimping Tools - For uninsulated lugs

	CT-80	Crimping tool with movable & revolving dies 8-80mm ²
	HX-50B	Hex crimping tool with movable & revolving dies 6-50mm ²
	HX-150BX	Hex crimping tool with movable & revolving dies 25 - 150mm ²
	HX-245B	Hex crimping tool with movable & revolving dies 70-240mm ²
	MT-120	Heavy Duty Point Crimping Tool 16 - 95mm ²
		MT-120

Crimping Tool Kit - with exchangeable dies		
Code	BM5345	ZD-922A
	BM5345	
	Complete Kit in a carry case for the following applications: <ul style="list-style-type: none"> • Insulated Terminals 0.25-6mm² • Boot Lace Terminals 0.5-4mm² • Boot Lace Terminals 6-16mm² • Barrel Open Terminals 0.5-6mm² • Uninsulated Terminals 0.5-10mm² 	Complete Kit in a carry case for the following applications: <ul style="list-style-type: none"> • Insulated Terminals 0.25-6mm² • Boot Lace Terminals 0.5-16mm² • Crimping of uninsulated terminals up to 10mm² • Coaxial Crimping
BM5345		ZD-922A

BM HYDRAULIC TOOLS

	Hydraulic Press - 3-in-1 Kit	Crimp Tool + Case	Cable Cutting Head	Chassis Punch Head	Hydraulic Crimp Tool Kit (50Kn)
Code	BM200	BM200PA	BM200T	BM200F	BM1824 (Kit c/w Dies)
Cable Size	10-185mm ²	10-185mm ²	Cutting Capacity:	Punching Capacity:	10-240mm ²
Output	50kN	50kN	• Alu/Cu Cable 32mmØ	• Cut-out Round 65mmØ	50kN
Dies	10-185mm ² (BM182) Uninsulated Terminals. Also crimps "C" Type terminals.	Order BM182 dies separately	• Copper Rod 25mmØ	• Cut-out Square 50x50mm	BM182 Dies for Uninsulated Terminals. Also crimps "C" Type terminals.
Features	Includes BM200A Crimping Head, BM200T Cable cutter & BM200F Punch Headstock, with Case	With Case	• Alu Rod 22mmØ	• Cut-out Rectangle 65 x 38mm	With Case
			• Steel Rod 16mmØ	Material: Plastic up to 3.0mm, Mild steel 1.5mm	

	Mechanical Crimping Tool	Dies For BM582, BM1824, BM182P, BM200		Crimping Headstock	Hex Dies For BM284				
		Code Hex	Size mm ²		Code	Size mm ²	Code	Size mm ²	
Code	BM582			BM284	BM184010	10	BM184012	120	
Cable Size	10-150mm ²			10-400mm ²	BM184016	16	BM184015	150	
Output	-			120kN	BM184025	25	BM184018	185	
Dies	Order BM182 dies separately			Order BM184 dies separately	BM184035	35	BM184024	240	
Features	With Case 805 x 220 x 100mm			For use with BM1600 pump on page 522	BM184050	50	BM184030	300	
					BM184070	70	BM184040	400	
					BM184095	95			
					C-Sleeve Dies for BM284				
					Code	Size mm²	Code	Size mm²	
					BM184210	10	BM184270	50-70	
					BM184225	16-25	BM184295	95	
					BM184235	35	BM184212	120-150	

	Round Punches (3mm Max)				For Mild Steel	Square Punches (3mm Max)				Round Punches - Stainless Steel			
	Code	Size mm Ø	Draw Stud	Pilot Hole Ø		Code	Size mm ²	Draw Stud	Pilot Hole Ø	Code	Size mm Ø	Draw Stud	Pilot Hole Ø
For Mild Steel													
	BMT1700	17	BM301	11.5	BMQ	BMQ30	30	BM311	19.5	BMTX305			
	BMT1950	19.5	BM301	11.5	BM311/2/3/4	BMQ46	46	BM312	19.5	BM301/2			
	BMT2250	22.5	BM301	11.5		BMQ68	68	BM313	28.5				
	BMT2550	25.5	BM301	11.5		BMQ92	92	BM313	28.5				
	BMT3050	30.5	BM301	11.5		BMQ138	138	BM314	28.5				
	BMT3250	32.5	BM302	17		Manual Draw Stud				Code	Size mm Ø	Draw Stud	Pilot Hole Ø
	BMT4000	40	BM302	17		BM301/B				BMTX225	22.5	BMX301	11.5
	BMT4500	45	BM302	17		HexBolt For BMT1700-BMT3050				BMTX305	30.5	BMX301	11.5
	BMT5050	50.5	BM302	17		BM302/B				BMTX400	40	BMX302	17
	BMT6200	60	BM302	17		HexBolt For BMT3025-BMT6200				BMTX500	50	BMX302	17
										BMTX600	60	BMX303	22.5

BM HYDRAULIC PUNCHING / CUTTING TOOLS

	Hand Hydraulic Hole Punch	Hydraulic Foot Pump	Cutting Headstock - Guillotine Cutter		Headstock for Punches
Code	BM185	BM1600	BM288	BM289	BM265
	<ul style="list-style-type: none"> Guaranteed 700 bar working Pressure Supplied with Carry Case Max Punch Size: Round 72mmØ Square 68 x 68mm See page 521 for Punching Dies 	<ul style="list-style-type: none"> Quick & Easy Die location with high and low pressure valves, allows for professional finish, due to foot operation. Pressure 700bar Max. Fast 2 Speed Operation 	<ul style="list-style-type: none"> 85mmØ Max Guillotine for Speed Cutting. Use with BM1600 	<ul style="list-style-type: none"> 110mmØ Max Guillotine for Speed Cutting. Use with BM1600 	<ul style="list-style-type: none"> Max thickness 3mm. Use with BM1600 & Punching Dies on page 521

HYDRAULIC CRIMPING / CUTTING TOOLS

	Hydraulic Pumps		Crimping Heads		Cable Cutter
	Works with CYO-0410H & SHP-210D & CPC-100	Works with CYO-0410H & SHP-210D & CPC-100	Works with CP-390 & CFP-800-1	Works with CP-390 & CFP-800-1	Works with CP-390 & CFP-800-1
Code	CP-390	CFP-800-1	CYO-410H	SHP-210D	CPC-100
	<ul style="list-style-type: none"> Hand-operated hydraulic pump Internal high pressure protection valve Max output: 700kgf/cm² /10 000psi Output range (Psi): 350-10 000 Oil capacity: 480cc PT3/8" oil pipe connection 	<ul style="list-style-type: none"> Foot-operated pump Internal high pressure protection valve Max output: 700kgf/cm² /10 000psi Output range (Psi): 350-10 000 Oil capacity: 650cc PT3/8" oil pipe connection 	<ul style="list-style-type: none"> Cable Size: 35-300mm² Dies Incl: 35, 50, 70, 95, 120, 150, 185, 240, 300 Output (T): 120kN Ram Stroke: 30mm For use in & outside DB Titanium Alloy Construction 	<ul style="list-style-type: none"> Cable Size: 25-240mm² Built-in revolving die Output (T): 120kN Ram Stroke: 22mm For use in & outside the DB 	<ul style="list-style-type: none"> Can cut cable up to Ø 100mm depending on the type of material. Solid copper = Ø 42mm Output: 7.5T Length: 570mm Max oil pressure: 700kgf/cm² (10 000 psi) PT 3/8" oil pipe capacity Spare Blade: CPC-100-BLADE

	Hydraulic Crimping Tools					Cable Cutter
Code	HP-210D	HP-240F	CYO-510B	YT-22860	YT-22862	YT-22872
Cable Size	25-240mm ²	25-240mm ²	50-400mm ²	10-120mm ²	16-300mm ²	4-20mmØ
Dies incl.	Built-in revolving die	16, 25, 35, 50, 70, 95, 120, 150, 185, 240	50, 70, 95, 120, 150, 185, 240, 300, 400	10, 16, 25, 35, 50, 70, 95, 120	16, 25, 35, 50, 70, 95, 120, 150, 185, 240, 300	-
Output	120kN	50kN	130kN	80kN	180-200kN	130kN
Features	<ul style="list-style-type: none"> Rugged heavy duty design Integrated rotatable head bits ensure no misplaced parts Audible warning of high/low pressure Rotatable head 180° 	<ul style="list-style-type: none"> Rotatable head 180° Safety pressure 	<ul style="list-style-type: none"> Rugged heavy duty design Insulated fiberglass handles Auto oil-bypass protection 2-stage pumping action Rotatable head 180° 	<ul style="list-style-type: none"> Open cut design for convenient operation Quick die change facility. Supplied with 8pc crimping die set. 	<ul style="list-style-type: none"> Open cut design for convenient operation Quick die change facility. Supplied with 11pcs crimping die set. 	<ul style="list-style-type: none"> Quick & easy cutting Strengthened Carbon Steel Blade Spare blade: YT22875

BATTERY CRIMPING / CUTTING / PUNCHING TOOLS



Supplied With

- Dies 16, 25, 35, 50, 70, 95, 120, 150, 185, 240, 300mm²
- 2 x Batteries + 1 x Charger (230VAC/18VDC)
- 1 Set Spare Cylinder Seals
- 1 Set Spare Safety Valve Seals
- Spare Battery Code: **BZ18/3AH**

Crimping Tool

Code	BZ-300
Crimp Size	16-300mm ²
Crimp Force	60KN
Crimps/Charge	300
Stroke	17mm
Battery	18V / 3Ah



Supplied With

- Dies 16, 25, 35, 50, 70, 95, 120, 150, 185, 240, 300mm²
- Punch Round 22.5, 25.4, 32.5, 40.5, 50.5, 61.5mm
- 2 x Batteries + 1 x Charger (230VAC/18VDC)
- 1 Set Spare Cylinder Seals
- 1 Set Spare Safety Valve Seals
- 1 x Crimping Adaptor & 1 x Punch Adaptor
- Draw studs 3/4", 7/16" + Spacer
- Spare Blade Code: **BZ600-BLADE**
- Spare Battery Code: **BZ18/3AH**

Crimping / Cutting / Punch Tool

Code	BZ-600UNV
Crimp Size	16-300mm ²
Crimp Force	60KN
Crimps/Charge	160
Cuts/Charge	70
Cutting Range	Ø40mm (Cu/AL + Armoured)
Punch/Charge	100
Punching Range	Ø22.5mm - Ø61.5mm
Stroke	42mm
Battery	18V / 3Ah



Supplied With

- Punch/die 22.5, 25.4, 32.5, 40.5, 50.5, 61.5mm
- Draw Studs 1 x 7/16 x 3/4" + 1 x 3/4 x 3/4"
- 2 x Batteries + 1 x Charger (230VAC/18VDC)
- 1 Set Spare Cylinder Seals
- 1 Set Spare Safety Valve Seals
- Spare Battery Code: **BZ18/3AH**

Punch Tool

Code	BZ-12
Punch Size	61.5Ø / 35 x 65mm
Punch Force	120KN
Punch/Charge	180
Stroke	25mm
Battery	18V / 3Ah

CABLE CUTTERS



Cable Cutters for Copper Cable

Code	Description
BM568	For cutting copper cable up to 35mm ²
BM5681	For cutting copper cable up to 60mm ²
BM570	For cutting copper cable up to 120mm ²
BM571	For cutting copper cable up to 240mm ²
BM572	For cutting copper cable up to 400mm ²

Cable Cutters for Aluminium & Copper Cables



Code	Description
LK-22A	For cutting copper & aluminium cables up to 22mm ²
LK-60A	For cutting copper & aluminium cables up to 60mm ²
CC-100L	For cutting copper & aluminium cables up to 100mm ²
HS-325A	For cutting copper & aluminium cables up to 150mm ²
HS-520A	For cutting copper & aluminium cables up to 240mm ²
LK-250	For cutting copper & aluminium cables up to 250mm ²
LK-500	For cutting copper & aluminium cables up to 500mm ²



LK-500/ LK-250

BOLT CUTTER

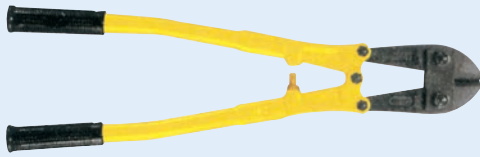

Heavy Duty Bolt Cutter

Code	Description
HT10-6213	610mm (24") Bolt Cutter
HT10-6214	762mm (30") Bolt Cutter

• Alloy Steel • Tubular Handle • Jaws hardened to HRC55-61

SHEARS

	X-PRO 50mm ² Shears	X-PRO Evo 50mm ² Shears	Cable Shears	Maxi Grip
Code	BM1325	BM1330	BM1335	BM1311
	<ul style="list-style-type: none"> Innovative new spring loaded opening action For the easy stripping and cutting of cables Especially designed blade for cutting of Aluminium & Copper cables up to a size of 50mm² Belt Clip Holder 	<ul style="list-style-type: none"> Ergonomic Design for stronger grip & increased comfort New design accommodates different hand sizes New reinforced handles Longer lever & micro serrated blades for easier cutting of cables up to 50mm² 	<ul style="list-style-type: none"> Wire Shears Robust ergonomic handle For the easy cutting and stripping of Aluminium and Copper cables up to a size of 35mm² Tempered stainless steel blade With safety lock 	<ul style="list-style-type: none"> Wire Shears Bi-Component handle for greater cutting force Non-slip serrated blades Tempered stainless steel blade Belt clip holder

ROPE ACCESSORIES

	Eye Bolts			Thimble	Clamp	Tensioner
Code	SB209333/M8	SB209333/M10	SB209333/M12	SB209331/6	SB209332/6.5	SB209336/8
Size	10mm(L)	13mm(L)	16mm(L)	6mm	6.5mm	8mm

SAND PAPER & SANDING BELTS

Floor Paper Rolls

Code	Description	Grit	Pcs/Pack	Packs/Box
FP-P60D/1	Floor Paper Strips	P60D	1	25
FP-P80D/1	Floor Paper Strips	P80D	1	25
FP-P100D/1	Floor Paper Strips	P100D	1	25

Sanding Belts

Code	Description	Grit	Pcs/Pack	Packs/Box
SB-75x532-P40/2	Sanding Belts - 75 x 532mm	P40	2	12
SB-75x532-P60/2	Sanding Belts - 75 x 532mm	P60	2	12
SB-75x532-P80/2	Sanding Belts - 75 x 532mm	P80	2	12

Water Paper Sheets

Code	Description	Grit	Pcs/Pack	Packs/Box
WP-P80C/4	Coarse Water Paper Sheets - 230 x 280mm	P80C	4	25
WP-P120C/4	Medium Water Paper Sheets - 230 x 280mm	P120C	4	25
WP-P222C/4	Fine Water Paper Sheets - 230 x 280mm	P222C	4	25

Cabinet Paper

Code	Description	Grit	Pcs/Pack	Packs/Box
CP-P60D/4	Coarse Cabinet Paper Sheets - 230 x 280mm	P60D	4	25
CP-P80D/4	Medium Water Cabinet Sheets - 230 x 280mm	P80D	4	25
CP-P120D/4	Fine Water Cabinet Sheets - 230 x 280mm	P120D	4	25

DRILLS & TAPS

High speed Drills (DIN338)		High speed Drills		SDS Plus		1st Cut Taps		Req Drill Size		1st,2nd&3rd Cut Taps (Set)		SDS Max		
Size Ø	Yellow Steel Drills		Masonry Drills (ZN-Plated)				1st Cut Taps	Req Drill Size	1st,2nd&3rd Cut Taps (Set)	Masonry Drills (ZN-Plated)				
	Code	Length (mm)	Code	Length (mm)	Code	Length (mm)				Size Ø	Code	Length (mm)		
Pack size	Pack of 10		Pack of 5		Each		Each	Set of 3	Each					
1.0	HSS-1	34										16.0	BP-C16-340	340
1.5	HSS-1.5	40										16.5		
2.0	HSS-2.0	49										17.0		
2.5	HSS-2.5	57										17.5		
3.0	HSS-3.0	61	MAS-3/5	60			TAP-3/1	2.5	TAP-3/3			18.0	BP-C18-340	340
3.2	HSS-3.2	65										18.5		
3.5	HSS-3.5	70										20.0	BP-C20-340	340
4.0	HSS-4.0	75	MAS-4/5	75	BP-C4-160	160	TAP-4/1	3.2	TAP-4/3			20.5		
4.2	HSS-4.2	75										22.0	BP-C22-340	340
4.5	HSS-4.5	80										22.5		
5.0	HSS-5.0	86	MAS-5/5	85	BP-C5-160	160	TAP-5/1	4.2	TAP-5/3			24.0	BP-C24-340	340
5.5	HSS-5.5	93		Each	BP-C5.5-160	160						24.5		
6.0	HSS-6.0	93	MAS-6	100	BP-C6-160	160	TAP-6/1	5.0	TAP-6/3			25.0	BP-C25-570	570
6.5	HSS-6.5	101										25.5		
		Pack of 5										28.0	BP-C28-570	570
6.8	HSS-6.8	109										28.5		
7.0	HSS-7.0	109	MAS-7	120								30.0	BP-C30-570	570
7.5	HSS-7.5	109										30.5		
8.0	HSS-8.0	117	MAS-8	120	BP-C8-160	160	TAP-8/1	6.8	TAP-8/3			32.0	BP-C32-570	570
8.5	HSS-8.5	117										32.5		
9.0	HSS-9.0	125										35.0		
9.5	HSS-9.5	125										35.5		
10.0	HSS-10.0	133	MAS-10	120	BP-C10-210	210	TAP-10/1	8.5	TAP-10/3			37.0		
10.2	HSS-10.2	133										37.5		
11.0	HSS-11.0	142										38.0		
12.0	HSS-12.0	151	MAS-12	150	BP-C12-210	210						38.5		
13.0	HSS-13.0	151			MAL-13	260						40.0		
14.0	HSS-14.0	160	MAS-14	150	BP-C14-210	210						40.0		



Drill Bit Kit - 101 Piece Kit

Code	LB-013		
Includes	19pcs - Hss Drills	1pc - Counter Sinking Bit	10pcs - Nut Drivers
	3pcs - Hss drills with Hex Shank	3pcs - Screw Finder	15pcs - 50mm Driver Bits
	4pcs - Hole Saw	22pcs - Miscellaneous Driver Bits	1pc - Magnetic Bit Holder
	5pcs - Flat Wood Drills	6pcs - Masonry Drills	
	6pcs - Wood Drills	4pcs - Drill Stopper	

Drill Press



Variable spindle

Code	ZJQ4116-A1
Power	350W
Speed	580 - 2500rpm
Spindle travel	50mm
Overall height	630mm
Chuck	13mm

16 pcs Tap & Die Set



TX-0802
Tap & Die Size: M3, M4, M5, M6, M8, M10, M12 1 x Tap Wrench / 1 x Die Handle

Tap Wrench



Code	Length	For Size
D312-001	125mm	M1-M8
D312-003	200mm	M3-M12

Impact Chisel



MI-F25-280

280(L) x 25(B)mm

Drill Sharpener



Code	Description
SND401	Drill
SND-STONE	Spare Stone

Drill Chucks



Keyless

CTDCP0023

Capacity	2-13mm
Female Thread	3/8-24UNF



Keyed

CHUCK-20

Capacity	Ø5 to 20mm
Taper Type	B22 (Metric DIN Std)
Diameter	64mm

DRILL SETS

	Twist Drill Sets				Masonry Drill Set	Jigsaw Blades
	 10 Pcs	 13 Pcs	 19 Pcs	 25 Pcs	 4 Pcs	 5 Pcs
Code	TX-H1001	TX-H1302-1	TX-H1902-1	TX-H2502	TX-M402-1	T118A
Description	1 to 10mm (1mm Increments)	1.5 to 6.5 (0.5 Increments) + 3.2 & 4.8mm	1.0 to 10.0mm (0.5mm Increments)	1.0 to 13.0mm (0.5mm Increments)	4, 5, 6, 8mm Ø ZN-Plated	For Metal 1-3mm

HOLE SAWS

	Fixed Hole Saws	Bi-Metal Hole Saws	Tungsten Carbide Tip (TCT)		
<ul style="list-style-type: none"> • High Speed Bi-Metal Edge welded to alloy steel for heavy duty cutting 			<div style="background-color: red; color: white; padding: 2px; display: inline-block;">NEW</div>		
Size Ø (mm)	Size Ø (Inches)	Code	Code	Code	Size Ø (mm)
16	5/8"	-	HS-16	TCT20	20
20	25/32"	TX-20	HS-20	TCT22.5	22.5
22.5	7/8"	TX-22	HS-22.5	TCT25	25
25	1"	TX-25	HS-25	TCT32	32
29	1 1/8"	-	HS-29	TCT40	40
30	1 1/16"	TX-30	HS-30	TCT50	50
32	1 1/4"	-	HS-32	<ul style="list-style-type: none"> • Complete with Arbor & Spring Extractor • Fast cuts • Stainless & all high alloy steels + Fibre Glass • Long service Life 	
35	1 3/8"	-	HS-35		
38	1 1/2"	-	HS-38		
40	1 9/16"	-	HS-40		
44	1 3/4"	-	HS-44		
48	1 7/8"	-	HS-48		
51	2"	-	HS-51		
54	2 1/8"	-	HS-54		
57	1 1/4"	-	HS-57		
60	2 3/8"	-	HS-60		
64	2 1/2"	-	HS-64	<ul style="list-style-type: none"> • Shank Size: 3/8" Hex • Thread Size: 1/2" • Fits to 16 - 30mm Hole Saw 	
73	2 7/8"	-	HS-73		
76	3"	-	HS-76		

Arbors - For use with HS Hole Saws



HAS-02

- Shank Size: 3/8" Hex
- Thread Size: 1/2"
- Fits to 16 - 30mm Hole Saw



HAS-04

- Shank Size: 7/16" Hex
- Thread Size: 5/8"
- Fits to 32 - 76mm Hole Saw



Accessories

Code	Description	Ø Size (mm)
HSD-01	10pcs Spare Drill Bit for HAS-02 & HAS-04	6.35 x 73
HSD-02	Adaptor for different Arbor Thread Size	1/2" - 5/8"

8 Piece Hole Saw Kit

Code	HSD-04
Consisting of: <ul style="list-style-type: none"> • 16mm (5/8"), 20mm (25/32"), 22mm (7/8"), 25mm (1"), 32mm (1 1/4") • 2 x Arbors <ul style="list-style-type: none"> 3/8" Hex to fit 16-30mm Hole Saw 7/16" Hex to fit 32-210mm Hole Saw • 1 x Adaptor 1/2" to 5/8" 	



16 Piece Hole Saw Kit

Code	HSD-16
Consisting of: <ul style="list-style-type: none"> • 12 x Hole Saws: <ul style="list-style-type: none"> 19mm (3/4"), 22mm (7/8"), 29mm (1 1/8"), 32mm (1 1/4"), 38mm (1 1/2"), 44mm (1 3/4"), 51mm (2"), 64mm (2 1/2"), 76mm (3"), 89mm (3 1/2"), 102mm (4"), 127mm (5") • 2 x Arbors <ul style="list-style-type: none"> 3/8" & 1/4" Hex with one 6mm pilot drill & 2.5mm allen key • 1 x Drive plate 	



POWER TOOL ACCESSORIES - ABRASIVES

Superflex Standard Cutting Wheel - Metal - Specification: AS30S B27 F2



Code	DIA.	Thickness	Hole Size	Shape	Max Speed		Box QTY
					M/Sec	RPM	
GTCW0001	115	3.0	22.2	41 Flat	80	13280	25
GTCW0002	125	3.0	22.2	41 Flat	80	12280	25
GTCW0003	150	3.0	22.2	41 Flat	80	10190	25
GTCW0004	180	3.0	22.2	41 Flat	80	8600	25
GTCW0005	230	3.0	22.2	41 Flat	80	6600	25

Superflex Quality Cutting Wheel - Metal (Light Duty Machines 2kw or Less) Specification: AS30R BF2E



Code	DIA.	Thickness	Hole Size	Shape	Max Speed		Box QTY
					M/Sec	RPM	
GTCW0006	350	3.0	25.4	41 Flat	80	4100	10

Superflex Standard Cutting Wheel - Stone Specification: CS302 B40 F2 (Mainly Used For Wall Chasing)



Code	DIA.	Thickness	Hole Size	Shape	Max Speed		Box QTY
					M/Sec	RPM	
GTCW0009	115	3.0	22.2	41 Flat	80	13280	25
GTCW0011	125	3.0	22.2	41 Flat	80	12280	25
GTCW0013	230	3.0	22.2	41 Flat	80	6600	25

Superflex Slimline Cutting Wheel - Metal & Stainless Steel (2 in 1) Specification: A46T BF



Code	DIA.	Thickness	Hole Size	Shape	Max Speed		Box QTY
					M/Sec	RPM	
GTCW0014	115	1.0	22.2	T41 Flat	80	13280	25
GTCW0017	125	1.0	22.2	T41 Flat	80	12280	25
GTCW0019	230	1.9	22.2	T41 Flat	80	6600	25

Superflex Slimline Cutting Wheel - Multi-Purpose - Specification: C60T BF



Code	DIA.	Thickness	Hole Size	Shape	Max Speed		Box QTY
					M/Sec	RPM	
GTCW0021	115	1.0	22.2	T41 Flat	80	13280	25
GTCW0022	230	1.9	22.2	T41 Flat	80	6600	25

Superflex Standard Angle Grinding Wheel - Metal - Specification: C60T BF



Code	DIA.	Thickness	Hole Size	Shape	Max Speed		Box QTY
					M/Sec	RPM	
GTCW0026	115	6.4	22.2	27 D/CT	80	13280	10
GTCW0032	230	6.0	22.2	27 D/C	80	6600	10

Industrial Flap Discs

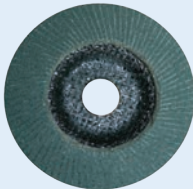

Code	DIA.	Hole	Grit	Box QTY
GTFD0030	115	22	AZ40	10
GTFD0031	115	22	AZ60	10
GTFD0032	115	22	AZ80	10
GTFD0033	180	22	AZ60	10

DIY Flap Discs

Code	DIA.	Hole	Grit	Box QTY
GTFD0034	115	22	AZ40	10
GTFD0035	115	22	AZ60	10
GTFD0036	115	22	AZ80	10

DIY Diamond Saw Blades



Code	DIA.	Thickness	Hole Size	Box QTY
GTCW0040	115	2.2/7	22.23	1
GTCW0041	125	2/7	22.23	1
GTCW0042	230	2.2/7	22.23	1

Professional Light Duty Diamond Disks



Code	dxD(mm)
DP-18580500	22.2 x 115
DP-18580520	22.2 x 230

Professional Medium Duty Diamond Disks



Code	dxD(mm)
DP-18570012	22.2 x 115
DP-18570042	22.2 x 230

CORE DRILLING MACHINE

	Core Drilling Machines c/w Stand		Core Drill Bits		Water Swivel Adaptor
Code	R1011	R1721	RC35-*	RC70-*	WATER SWIVELS
Supply	220-240VAC	220-240VAC	1/2" Box Thread	1 1/4" UNC Thread	Fits a standard 1/2" chuck Allows wet core drilling using RC35 core bit Capacity: 12 - 77mm Diameter No hammer action required
Watts	1100W	1700W	* Add size to code:	* Add size to code:	
Shaft Speed	970rpm	450/900rpm	20mm (ID: 15mm L: 400mm)	52mm (ID: 44mm L: 450mm)	
Core Bit Type	RC35	RC70	25mm (ID: 20mm L: 400mm)	67mm (ID: 59mm L: 450mm)	
Bit Sizes	60-120mm	40-300mm	32mm (ID: 27mm L: 400mm)	109mm (ID: 101mm L: 450mm)	
Output Shaft Thread	1/2" Box	1 1/4 UNC	52mm (ID: 46mm L: 400mm)	117mm (ID: 109mm L: 450mm)	
Weight	6.1kg	18.2kg	Suitable for wet drilling of reinforced concrete/masonry		

POWER TOOLS

	NEW		Electric Blower			NEW		Electrical Wall Chaser		
	Code	EB-J30A	Supply	220-250V 50Hz		Code	WC-J3050	Supply	220V 50Hz	Power
		Rated Input	550W			Blade Diameter	125mm	Cutting Depth	40mm	
		Air Volume	2.8m³/h			Max Cutting	50mm	Wet Cutting	Yes	
		Speed	500-15000r/min			Spare Blade x 5	J3050-BLADES			
Heat Guns		Glue Gun								
Code	PLD2230	PLD2232	ZD-509	ZD-7						
Power	2000W	2000W	1500W	40Watt Glue Gun						
Features	3 Speed / Temperature Settings: 1: 50°C / 500//min 2: 450°C / 250//min 3: 600°C / 500//min	3 Speed / Temperature Settings 1: 50°C / 250//min 2: 50-600°C (Adj.) / 250//min 3: 50-600°C (Adj.) / 500//min Able to work continuously without overheating.	Hot Airgun Low/Off/High 200°C – Off – 500°C		ZD-7GLUE					
					6Pcs Ø 11 x 100mm					
					ZD-7GLUE-300					
					6Pcs Ø 11 x 300mm					

12VDC Wrench & Jack Auto Kit for every car owner



Code	HF-12
Impact Wrench	Electric Jack
<ul style="list-style-type: none"> • Voltage: 12VDC • Working Current: ≤8A • Max Torque: 300 NM • Output Shaft: 1/2"m (13mm) 	<ul style="list-style-type: none"> • Voltage: 12VDC • Max Load: 950kg • Working Current: ≤10A • Lifting Height: 22cm (12-34cm)



PROFESSIONAL POWER TOOLS

Impact Drills

			
Code	GSB-13-RE	GSB-16-RE	GSB-19-2-RE
Power	600W	701W	850W
No Load Speed	0 - 2800rpm	0 - 3000rpm	0 - 777 / 1990RPM
Impact Speed	—	—	1000 / 3000rpm
Chuck Size	1.5 - 13mm	1.5 - 13mm	1.5 - 13mm
Variable Speed	Yes	Yes	Yes
Weight	1.7kg	1.9kg	2.6kg



Impact Drill/Driver

Drill/Driver

Heat Gun

			
Code	GSB-18-2-LI	GSR-180-LI	GHG23-66
Power	63 / 24Nm	45 / 19Nm	Power 2300W
No Load Speed	0-500 / 0-1900rpm	0-400 / 1300rpm	Temp. 50-650°C
Impact Speed	—	—	Airflow 150-500l/min
Chuck Size	1.5 - 13mm	1.5 - 10mm	Weight 0.67kg
Variable Speed	Selectable	Selectable	Supplied Glass Protection Nozzle 75mm Surface Nozzle 50mm
Weight	1.2kg	1.4kg	

Rotary Hammer Drills

			
Code	GBH-2-20-D	GBH-12-52D	GBH-5-40D
Power	650W	1700W	1150W
No Load Speed	0 - 1300rpm	0 - 220rpm	170 - 340rpm
Air Flow	0 - 4200ipm	1750 - 2150ipm	1500 - 3050ipm
Chuck Size	SDS-Plus	SDS-Max	SDS-Max
Weight	2.3kg	11.5kg	6.8kg

Sabre Saw

Jig Saw

Metal Cut-Off Tool

			
Code	GSA-1100-E	GST-150-BCE	GCO-2000
Power	1100W	780W	2000W
No Load Speed	0 - 2700rpm	500 - 3100rpm	3500rpm
Features	Stroke 28mm Cutting Depth wood 230mm Cutting Depth metal 20mm	26mm Cutting Depth wood 150mm Cutting Depth Alu 20mm	Disc Ø: 355mm Spindle Lock Cut Capacity L 0° 138x138mm
Weight	3.6kg	2.7kg	17kg

PROFESSIONAL POWER TOOLS

	Angle Grinders		
			
Code	GWS-6700	GWS-850C	GWS-17-125-CI
Power	670W	850W	1700W
No Load Speed	12000rpm	11000rpm	11500rpm
Spindle Size	M14	M14	M14
Disc Diameter	115mm	125mm	125mm
Weight	1.8kg	1.9kg	2.4kg
	Angle Grinders		Blower
			
Code	GWS-22-230-H	GWS-26-230-B	GBL-800-E
Power	2200W	2600W	820W
No Load Speed	6500rpm	6500rpm	16000rpm
Spindle Size	M14	M14	-
Disc Diameter	230mm	230mm	-
Blow Rate	-	-	4.5m³/h
Weight	5.2kg	5.2kg	1.8kg

DIY POWER TOOLS

	Impact Drill	Glue Gun	Heat Gun
			
Code	PSB-500-RE	PKP-18-E	PHG-500-2
Power	550W	200W / 16W	1600W
Features	No load speed 50 - 3000rpm Impact speed 33000ipm Keyless Chuck 10mm	Temp 200°C Glue stick Ø11mm Glue Capacity 20gr/min	Temp 300/500°C Air flow 240/450l/min Thermal trip
Weight	1.5kg	0.35kg	0.75kg
	Angle Grinder		Jig Saw
			
Code	PWS-700-115		PST-650
Power	700W		500W
Features	No load speed 11000rpm Disc Ø 115mm Spindle M14		Speed 3100spm Cutting depth Wood 65mm Cutting depth Steel 4mm
Weight	1.68kg		1.6kg

NEW

CORDLESS POWER TOOLS - LI-ION

	20V Cordless Drill	20V Cordless Hammer Drill	20V Cordless Impact Driver	20V Cordless Impact Wrench	20V Cordless Rotary Hammer
All supplied c/w 2.0Ah Li-ion Battery & Fast Charger LED Work Light					
Code	LCD777-1S	LCD777-1SC	LCW777-1A	LCW777-1B	LCH777-1
No Load Speed	0-400 / 0-1400RPM	0-440 / 0-1650RPM	0-2800RPM	0-2800RPM	0-900RPM
Max Torque	35Nm	50Nm	180Nm	250Nm	—
Torque Settings	25 + 1(Drill)	20 + 1(Drill) + 1(Hammer)	—	—	—
Chuck	2-13mm	2-13mm	1/4" Hex	1/2" Square	SDS Plus
Impact Rate	—	0-7920 / 0-24700BPM	0-3600BPM	0-3600BPM	0-5000BPM
Features	<ul style="list-style-type: none"> • 2 Speed • Forward / Reverse • Magnetic Bit Holder • Spare Battery: LY777/2.0AH 	<ul style="list-style-type: none"> • 2 Speed • Forward / Reverse • Magnetic Bit Holder • Side Handle • Spare Battery: LY777/2.0AH 	<ul style="list-style-type: none"> • Durable Gearbox • Forward / Reverse • Magnetic Bit Holder • Spare Battery: LY777/2.0AH 	<ul style="list-style-type: none"> • Durable Gearbox • Forward / Reverse • Spare Battery: LY777/2.0AH 	<ul style="list-style-type: none"> • Impact Force: 1.1J • 2 Function Rotary Selector (Drill/Hammer) • Forward / Reverse • Spare Battery: LY777/2.0AH
	20V Cordless Jig Saw	20V Cordless Glue Gun	20V Cordless Inflator	20V Orbital Sander	20V Reciprocating Saw
All supplied c/w 2.0Ah Li-ion Battery & Fast Charger					
Code	LCJ777-1	LCA777-1	LCB777-1	LCO777-1	LCR777-1
Description	No Load Speed: 0 - 2700SPM Stroke Length: 25mm Bevel Angle: 0-45° Cut Capacity: 80mm for Wood/ 5mm Steel & 12mm Aluminium	Runtime: 3.5hours Glue Sticks: ø10-ø12 Charging Time: 1 Hour	Air Speed:40km/hour Air Flow: 57mm³/hour Noise: ≤86dB	2000-10000RPM 125mm	0-2600SPM Wood 100mm Mild Steel 6mm
Features		<ul style="list-style-type: none"> • 2-Finger-trigger for enhanced control • Led On/Off indicator light 	<ul style="list-style-type: none"> • For High Volume Inflating & Deflating 	<ul style="list-style-type: none"> • Dust Collection Bag • Variable speed regulator • Spare Battery: LY-777/2.0AH 	<ul style="list-style-type: none"> • Safety Switch • Pendulum Setting • Quick Blade Change System • Spare Battery: LY-777/2.0AH
	20V Cordless Angle Grinder	20V Cordless Blower		3.6V Cordless Screwdriver	12V Cordless Drill
All supplied c/w 2.0Ah Li-ion Battery & Fast Charger			Supplied c/w Li-ion Battery & Charger		
Code	LCG777-1	LCGB777-2	Code	LY529	LCD666-1S
Description	No Load Speed: 10000RPM Disc Dia: 115/125mm Bore: Ø22mm	Max Idle Speed: 0-18000RPM Max Air Speed: 270km/h Max Flow Rate: 2.6m³/min Noise: ≤85dB	No Load Speed Max Torque Torque settings Chuck Battery Features	180rpm 4Nm 10+1(Drill) 1/4" Hex Built-in	0-350 / 0-1300RPM 25Nm 19+1(Drill) 0.8-10mm 2.0Ah
Features	<ul style="list-style-type: none"> • Spindle Lock • Quick Change Guard • 3-Position Handle Fixing • Spare Battery: LY777/4.0AH 	<ul style="list-style-type: none"> • 2 in 1, Blower and Vacuum Switch • Air volume Setting: Low, Medium, High • Accessories: Blow Nozzle, Dust bag 	<ul style="list-style-type: none"> • Supplied in case with 55pc bit set. • 60° Swivel Handle for ease of use • LED Work Light • LED Batt. Indicator 	<ul style="list-style-type: none"> • 2 Speed • Forward / Reverse • LED Work Light • Magnetic Bit holder • Spare Battery: LY666/2.0AH 	

TEST INSTRUMENTS, TOOLS & GENSETS

NEW

CORDLESS POWER TOOLS BATTERIES & CHARGERS

	20V (Li-ion) Battery	20V Fast Charger	777 Charging Pal
Code 2.0Ah	LY777/2.0AH	LYKC777	LY777-USB-2000
Code 4.0Ah	LY777/4.0AH	Charging Current: 2.3A	Input Voltage: 15-21V Output Voltage: 5V Input Current: 1.5A LED Light: 0.6W USB Connection 60 Lumen Torch Cell Phone Charger
Description	c/w LED Charge State Indicator		

CORDLESS POWER TOOLS

	Reciprocating Saw	Jig Saw	Delta Sander
Code	WLP827-01	WLP821-01	WLP825-01
Power	18V Ni-cd Battery	18V Ni-cd Battery	18V Ni-cd Battery
No Load Speed	2800rpm	1700rpm	6000rpm
Cutting Capacity	Maximum Cutting Depth: 101mm Stroke length: 22mm	Wood: 50mm, Mild Steel: 3mm Bevel angle range: 0-45°	Sanding Pad: 90 x 90 x 90mm
Spares	Wood blade: WL-RS01W/5 Metal blade: WL-RS02M/5 Battery: WL-BA01 Charger: WL-CH01	Wood blade: WL-JS01W/5 Metal blade: WL-JS02M/5 Battery: WL-BA02 Charger: WL-CH02	Spare Delta Sanding Paper: WL-DS01/10 Battery: WL-BA02 Charger: WL-CH02

NEW

AUTOMATIC SELF-ADJUSTING HAND TOOLS

	Pipe Wrench 9"	Pipe Wrench 16"	Wrench 8"	Stud Remover / Wrench
Code	PW10305	PW2060AL	SP622SS	SW520SS
Description	Automatically size around any pipe or bar Slip Free Opening: 10mm- 30mm	Automatically size around any pipe or bar Slip Free Opening: 20mm- 61mm	Self Adjusting & Automatically size around any nut or bolt Slip Free Capacity: Metric 6 to 22mm American 1/4" to 7/8" Imperial 5/32" to 1/2"	For removing & Tightening any stud on round bar Slip Free Ratchet type Capacity: 6 to 20mm

PROFESSIONAL POWER TOOLS

NEW



Angle Grinder

Impact Drill



Code	MCOP1627	MCOP1593	MCOP1573	MCOP1592
Power	2200W	850W	500W	900W
No Load Speed	-	-	Variable Speed	Variable Speed
Chuck Size	-	-	Ø13mm	Ø13mm
Disc Diameter	Ø230mm	Ø115/125mm	-	-
Spindle Size	Ø22mm	Ø22mm	-	-
Weight	6.9kg	2.7kg	2.3kg	2.9kg

Drill/Grinder Combo



Code	MCOP1584	
Type	Drill	Grinder
Power	500W	650W
No Load Speed	Variable Speed	Variable Speed
Chuck Size	Ø13mm	-
Disc Diameter	-	Ø115mm
Size (mm)	265 x 300 x 75	120 x 300 x 140
Weight	2.3kg	3.4kg

WELDING MACHINES

AWELCO
Insulation
Class H
IP21

Heavy Duty

Inverter

DIY Inverter



Code	WM-41124	WM-42305	WM-11000	WM-56140	MCOW4054
Voltage	1PH 230/400V	1PH 230/400V	1Ph/230V	1Ph/230V	1Ph/230V
Absorbed Power	4.8KVA	4.4KVA	1.2KVA	2.6KVA	-
Welding Current	40-170A	50-180A	33-95A	5-135A	140A
Electrode Ø	1.6-3.2mm	1.6-4mm	0.8-1mm	1.6-3.2mm	1.6- 3.2mm

All Awelco welding machines supplied with electrode holder and earth clamp.

Inverter Welders

MMA: c/w Cable Sets ready to use
INMIG: c/w Earth Cable & MIG torch
Supply Voltage: 230VAC



Code	S-ARC-200LP	S-EVO-220	SD-MMA-140	S-MMA-210	S-INMIG-205
Type	MMA	MMA	MMA	MMA	MIG / MMA
Rated Input Capacity	7.9KW	7.9KW	4.1KW	7.1KW	6.4KW
Current Adjustment	180A	20-200A	10-140A	10-200A	30-180A
Output Voltage	66V	62Vw	78V	78V	60V
Rated Duty Cycle	60% @180A	60% @ 200A	60% @ 140A	60% @ 200A	60%
Electrode Diameter	1.6-3.2MM	1.6-5.0MM	1.6-3.2MM	1.6-4.0MM	N/A
Features	IGBT Inverter Technology Anti Sticking Hot Start / Arc Force	IGBT Inverter Technology Anti Sticking LCD Screen	IGBT Inverter Technology Anti Sticking	IGBT Inverter Technology Anti Sticking	Auto Wire Feed

NEW

WELDING ACCESSORIES

	Welding Helmet Lenses 108 x 51mm		Brush Wire	Electrode Holder		
Code	TOOW4242G	TOOW4242H	TOOB38	EWC0074	TOOW4240	
Description	Shaded Glass	Clear Glass	5 Rows	Collet Type, 600A	KD Type, 500A	
	Earth Clamp	Chipping Hammer	Bench Vice Swivel Heavy Duty		Sash Clamps	
Code	TOOW4238	JW-AC012	YT-6501	YT-6503	C061SK	C122SK
Description	300A	500g	100mm	150mm	600mm	1200mm
	Protection Goggles	Safety Spectacles	Safety Spectacles	Safety Glasses with Side Shield		
Code	SB216040	EURO1	EURO2	JW-SFT028	JW-SFT030	
		Black Frame	Sporty Look	Clear	Amber	
	Wire Cup Brushes			Bulk Mild Steel Electrodes		
Code	WB-R-65	WB-R-75	WB-R-100	JW-E1025	JW-E1032	
Description	Ø65 x M14	Ø75 x M14	Ø100 x M14	Mild Steel Electrodes 5kg / 2.5mm	Mild Steel Electrodes 1kg / 3.2mm	
	G Clamps	Welding Clamp Magnets	General Purpose Welding Rods	6 Pcs Welding Kit	Welding Cable Set	
Code	C075GK 75mm	TOOW4235 Small	ELE001 12pcs, 2.0mm	TOOW4237A	EWCAB1070	
	C150GK 150mm	TOOW4234 Medium	ELE002 10pcs, 2.5mm	<ul style="list-style-type: none"> • Flip front face shield • 2.5 x 16mm Green welding cable with earth clamp • 2.5 x 16mm Green welding cable with electrode holder • 5 Row wire brush • Metal Chipping Hammer • Pair of welding gloves 	<ul style="list-style-type: none"> • 1x 300A Electrode Holder • 1x 300A Earth Clamp • 2x 10-25 Dinse Connectors (Jack Plugs) • 2x 1.5m x 25mm² Blue Welding Cables 	
	C200GK 200mm	TOOW4233 Large	ELE003 8pcs, 3.2mm			



JW-SFTB-002



JW-SFTB-005

Welding Helmets

Code	JW-SFTB-002	JW-SFTB-005
Sensitivity Control	Low / High	Auto
Power Supply	2 x AAA Battery	Solar Powered -Lithium Battery
Switching Time	1 / 15 000s	1/5000s

- Light State: DIN4 • Grinding Function
- Shade Control: External, Variable
- Dark State: Variable Shade 9-13

NEW

SAFETY ACCESSORIES

	Heavy Duty Winter Grip - Latex Palm	Cut Resistant - Latex Palm	Light Duty - Latex Palm	Red PVC / Knit-Wrist	Candy Strip Rigger
	 Size: 9 EN388: 4231	 Size: 9 EN388: 3544	 Size: 10 EN388: 3111	 Size: 9 EN388: 4121	 Size: 9
Code	G074-9	G060-9	G057-10	G013-9	G010-9
	Green Lined Welding - Wrist	Green Lined Welding - Elbow	Chrome Leather Short	8" Chrome Leather	8" Red Heat Resistant
	 Size: 10	 *Size: 9 or 10	 Size: 10	 *Size: 9 or 10	 *Size: 9 or 10
Code	G023-10	G022-*	G001-10	G004-*	G1028-*
	Mig Welding Glove	Green Nitrile Gloves	Black Rubber Builders Gloves	Red PVC open Cuff	Dust Mask
	 *Size: 9 or 10	 Size: 10	 Size: 10	 Size: 10	
Code	G012-*	G033-10	G018-10	G016-10	FFP1-1
	Dust Mask	Safe Face Shield	Chrome Leather Apron	Ear Muffs	Ear Plugs Disposable
					
Code	FFP2-1	TOOG774	LA-90	TOOE502	TOOE505
	T-shirts 145g/m ² *Sizes range from: S - 2XL (See Size Chart)		Safety Shoe 	Safety Boot 	*Add size to code: 2-13 SF001 : SABS and CE EN ISO 20345 approved safety boot with genuine leather upper and dual density PU sole. This robust boot also has a steel toecap with impact protection of 200 joules and is heat resistant up to 90°C. • Anti-static easy removable inner sole • Oil, slip & shock resistant
Code	TST145-BL*	TST145-WH*	SF002-*	SF001-*	
	Conti Suits				Dust Coat
	Acid/Flame Resistant c/w Reflective Tapes 				
Code	AF-CG34-*	J54001N-*	RB001-*	GM002-*	DC003-*
	Green	Navy Blue 100% Cotton	Royal Blue	Navy Blue Denim Material	Royal Blue
Code	AF-CNB34-*	*Add size to code: S (Small), M (Medium), L (Large), XL (Xtralarge) 2XL (XXtralarge), 3XL (XXXlarge), 4XL (XXXXLarge)			
	Navy Blue				
					Size Chart (mm)
		Size	Chest	Waist	
		XS	72-77	72	
		S	82-87	72-77	
		M	92-97	82-87	
		L	102-107	92-97	
		XL	112-117	102-107	
		2XL	122-127	112-117	
		3XL	132-137	122-127	
		4XL	142-147	132-137	

TEST INSTRUMENTS, TOOLS & GENSETS

SAFETY ACCESSORIES

3M



3M Comfort Grip Gloves

Perfect for light to medium duty jobs that require precision handling, even in hot and sweaty conditions.

Code	Includes
WX300921193	Large
WX300921201	Xtra-Large

Characteristics:

- Exceptional comfort and breathability: Thin foam coating provides high breathability for maximum comfort.
- Fine gauge knit nylon liner provides flexibility and padding
- High Durability: Unique nitrile formula offers resistance to abrasion.
- Machine washable

Benefits:

- Sweat Protection
- Maximized Tactile Sensitivity
- Excellent Dexterity
- Oil Resistant

P3

NEW

PRESSURE WASHERS



Code	MCOP1507	MCOP1508	MCOP1510
Power Rating	1350W	1850W	2200W
Rated Pressure	65Bar	95Bar	110Bar
Rated Flow	360L/H	360L/H	360L/H
Nett Weight	6kg	9kg	14kg
Supplied with	Variable Nozzle, 3m Hose, Detergent Bottle, Coupler/Connector	Variable Nozzle, 5m Hose, Detergent Bottle, Coupler/Connector	Variable Nozzle, 7m Hose, Detergent Bottle, Coupler/Connector

NEW

COMPRESSORS

Direct Drive



Belt Drive



Oil Free



Code	MCFRC100	MCFRC102A	MCFRC221	MCFRC228	MCFRC241	MCFRC243
Compressor Type	Direct Drive	Direct Drive	Belt Drive	Belt Drive	Direct Drive/Oil Free	Direct Drive/Oil Free
Tank Capacity	24L	50L	100L	150L	24L	50L
Motor Size	1.1KW / 1.5HP	1.5KW / 2HP	1.5KW / 2HP	2.2KW / 3HP	0.55KW	2 x 0.75KW
Input Power	230V/50Hz	230V/50Hz	230V/50Hz	230V/50Hz	230V/50Hz	230V/50Hz
Max Pressure	800Kpa (8 Bar)	800Kpa (8 Bar)	800Kpa (8 Bar)	800Kpa (8 Bar)	700Kpa (7 Bar)	700Kpa (7 Bar)
Free Air Delivery	@700Kpa:65l/m	@700Kpa:105l/m	@700Kpa:130l/m	@700Kpa:250l/m	@600Kpa:50l/m	@600Kpa:150l/m
Piston Displacement	138l/Min	206l/Min	165l/Min	370l/Min	206l/Min	2 x 138l/Min



Tradeair Compressor Oil

Code	T0001286
Capacity	1 Litre

Used for the following applications:

- Tyre Centers
- Supermarkets
- Car Washes
- Bakers
- Petrol Stations
- Laboratories
- Garages

Used by the following Professionals:

- Dentists
- Mechanics
- Spray Painters
- Also useful for any Small Business or DIY enthusiasts

MET

NEW

AIR ACCESSORIES

	Air Duster	Wash Gun	Sand Blasting Gun	Air Brush Set	Tyre Inflator Gun Pro/Kit	
Code	TOOS1751	PAB1211	PAB1210	PAB1209*	PAB1204	
Compressor Pressure	1.1KW 3-8 Bar	1.1KW 4-7 Bar	2.2KW/3HP 6 Bar	Set consists of: 22cc Cup, Hand piece protective cap, 5cc Metal cap, 60cc Mixing jar with lid, Spray jar, PVC Airline hose with adapters, Spanner.		1.1KW 3-8 Bar
Application	Blowing & Cleaning	Cleaning: Car Bodywork, Parts, Drains & Patios	Removes All Paints & Rust spots, Prep for Painting			Inflate: Car Tyres, Bicycle Tyres, Air Beds, Footballs etc.
	Gravity Feed Spray Gun	Suction Feed HP Spray Gun	Delux Mini HVLP Spray Gun	PVC Airline Hose	PVC High Pressure Hose	
	Spare Cup TOOS1792					
Code	TOOS1789	TOOS1785	TOOS1790	TOOH910	TOOH501	TOOH506
Compressor Pressure	1.5KW or above 3.5 - 4.8 Bar	1.5KW -2HP 3.5 - 4.8 Bar	1.5KW or above 2 - 5.5 Bar	10m Length Ø6mm	20m Length Ø6mm	100m Length Ø6mm
Cup Capacity	600ml	1000ml	100ml	10m Length Supplied Fitted with: TOOC349 Air Connectors Both Ends		
Air Consump.	228L/Min	280L/Min	160-300L/Min	• Ideal for pressure lines & Compressors • 1750kPA • Air/Water hose • Weather & Abrasion resistant		
Fluid Nozzle	Ø1.4mm	Ø2.0mm	Ø1.4mm			
Features	Paint Flow, Fan Adj, Air Control.	For professional quality	Non-Bleeder Type			

* Suitable for: Hobby enthusiasts & model makers: Spraying with Cellulose & Enamel

NEW

AIR CONNECTORS

Code	TOOC340	TOOC341	TOOC342	TOOC344
Connect 1	Quick Connect Female	Quick Connect Male	Quick Connect Male	Air Hose Fitting - 8mm
Connect 2	BSP1/4" Female	BSP1/4" Male	BSP1/4" Female	Quick Connect Male
			Inline Lubricator 	Coupler 5Pcs Air Hose Connector
Code	TOOC346	TOOC349	PAB1222	TOOC348
Connect 1	Air Hose Fitting	Air Hose Fitting - 6mm	Helps to reduce wear on air tools. Automatically lubricates air line system.	Kit Includes: • TOOC346 • TOOC342 • TOOC340 • TOOC344 • TOOC341
Connect 2	BSP1/4" Male	Spray Gun Fitting		

NEW

TOOL BAGS

	Professional Trolley Tool Bag 42 Pockets 	Tool Bag with Tubular Handle 56 Pockets 	Super Open Mouth Tool Bag 24 Pockets 	
Code	SB-L001	SB-T017	SB-S002	
Fabric	Polyester 600D	Polyester 600D	Polyester 600D & 1680D	
Pockets	10-Exterior, 32-Interior	14-Exterior, 42-Interior	15-Exterior, 9-Interior	
Bag Size	360 x 250 x 430mm	490 x 280 x 370mm	420 x 300 x 250mm	
Capacity	25kg	25kg	25kg	
Features	Three-Step Heavy Duty Trolley with stop	Foldable Sides	Wide Opening	
	Popular Lady's Tool Bag 15 Pockets 	Roller/Back-Pack Tool Bag 9 Pockets 	Back-Pack 20 Pockets 	
Code	SB-S005	SB-P001	SB-P003	
Fabric	Polyester 600D	Polyester 600D	Polyester 600D	
Pockets	12-Exterior, 3-Interior	4-Exterior, 5-Interior	5-Exterior, 15-Interior	
Bag Size	300 x 170 x 220mm	360 x 250 x 540mm	370 x 160 x 460mm	
Capacity	15kg	20kg	20kg	
Features	-	Roller or Back-Pack on Wheels	c/w Rubber Bottom	
	Multi Purpose Bag 12 Pockets 	Tool Bag with Seat 6 Pockets 	Handy Tool Bag 13 Pockets Tool-Bag with Shoulder Strap 	Back Pack 
Code	SB-B023	SB-M005	SB-C003	SB210402
Fabric	Polyester 600D	Polyester 600D	Polyester 600D	Industrial Nylon
Pockets	8-Exterior, 4-Interior	6-Exterior	12-Exterior, 3-Interior	5-Exterior, 2-Interior
Bag Size	330 x 570mm	420 x 290 x 310mm	240 x 240 x 420mm	400 x 150 x 460mm
Capacity	8kg	80kg	15kg	16kg
	Utility Vest Kit 14 Pockets 	Hands-free Vest <ul style="list-style-type: none"> Adjustable - 1 size fits all Heavy Duty material & 3 Zippers 	Belt Tool Pouch <ul style="list-style-type: none"> Universal 	Sling Bag 
Code	SB-G005	SB210404	EUROMARIO	SB210401
Fabric	Polyester 600D	Polyester 600D	Industrial Nylon	Industrial Nylon
Pockets	14-In total	7 Pockets	3-Exterior, 2-Interior	2-Exterior, 2-Interior
Bag Size	650 x 500mm	500 x 595mm	Belt Mount	350 x 180 x 330mm
Capacity	-	-	-	10kg

TOOL CASES

Aluminium Tool Boxes	Steel Canterlever	Steel Tool Box	Steel 3-in-1 Combo	Plastic Trolley Case
MJ-3083 520L x 210H x 230W	MJ-20565 565L x 215H x 220W	SB210202 484L x 165H x 154W		
MJ-3085 594L x 210H x 230W	SB210206 404L x 195H x 200W	SB210211 • 4 Drawers and top compartment Toolbox • On wheels • Lockable • 668L x 386H x 316W	JF-A300ABC 581 x 297 x 266H 495 x 285 x 222H 460 x 204 x 181H	MJ-2055 712H x 315D x 485W

Plastic Tool Boxes

MJ-30019D 485L x 270H x 245W	MJ-10571 420L x 230H x 200W	MJ-10555A 395L x 235H x 175W	MJ-12056 500L x 240H x 260W

Tool Cabinets • 1st drawer includes division boxes, other 3 drawers include dividers

Code	ELS-274M	ELS-274MA	ELS-276M	ELS-276MA
Size (mm)	863H x 1070W x 515D	1333H x 1070W x 515D	863H x 1070W x 515D	1333H x 1070W x 515D
Drawers (included)	4 x 150H	4 x 150H	2 x 75H; 2 x 100H; 1 x 150H	2 x 75H; 2 x 100H; 1 x 150H
Colour	Blue	Blue	Blue	Blue

Mobile Tool Cabinets • 1st drawer includes 12 division boxes, other drawers have 3 compartments each

Code	ELA-185M	ELA-185MA	HL3103-A
Size (mm)	1000H x 500W x 630D	1480H x 500W x 630D	950H x 960W x 570D
Drawers (included)	1 x 100H; 4 x 150H	1 x 100H; 4 x 150H	3 x 65H; 1 x 145H; 1 x 225H
Colour	Red	Red	Stainless Steel

12 Free hanger hooks incl.

PLASTIC TOOL BOX ORGANISERS

2 Door Storage Boxes		Storage Box	Storage Drawers	
ZD-B2	MJ-10237	MJ-46368	MJ-10184	MJ-10219
2 sides can open independantly Tough Transparent lids Adjustable partitions Total of 32 Compartments Size: 295L x 220H x 76Wmm	2 sides can open independantly Tough Transparent lids Adjustable partitions Total of 22 Compartments Size: 370L x 300H x 80Wmm	Single Lid opening Tough Transparent lid Adjustable partitions Total of 26 Compartments Size: 460L x 360H x 80Wmm	4 Pull-out drawers Single Top compartment with Transparent lid Total of 21 Compartments Size: 415L x 225H x 240Wmm	3 Pull-out drawers 2 Top Compartments with Transparent lids Total of 17 Compartments Size: 400L x 205H x 290Wmm
Small 2 Door Storage Box	Accessory Box	Storage Box	Component Separator Box	Aluminium Tool Case
ZD-B3	MJ-10310	HL3021	ZD-B4	SB210310
2 sides can open independantly Tough Transparent lids Fixed partitions Total of 13 Compartments Size: 162L x 99W x 45Hmm	Single Lid opening Tough Clear lid/ Quick view Fixed partitions Total of 18 Compartments Size: 310L x 200W x 45Hmm	Single Lid Opening Tough Transparent Lid Total of 26 Adjustable Compartments Size: 460L x 330W x 75Hmm	Single Pull-out drawer Small compact Clear Tray View from sides Total of 3 Compartments Size 156L x 92W x 53Hmm	Aluminium Carry Case Formed Foam Cut-outs Adjustable partitions Total of 6 Compartments Size: 460L x 335W x 150Hmm

NEW

SHELVING

The economical, aesthetically pleasing, DIY, quick assembly (no screws) shelving. Ideal for the Store, Garage, Workshop, Office or the Garden Shed

FLAT PACKED 4 TIER: 820 x 320 x 65mm 5 TIER: 930 x 470 x 65mm	ADIY3903W	ADIY3904G	ADIY3901W	ADIY3902G
Code	White	Grey	White	Grey
Colour	White	Grey	White	Grey
Description	5 Shelf, Loading: Max 250kg per Shelf, Up to 1250kg Total Weight Size: 1830 x 920 x 458mm		4 Shelf, Loading: Max 150kg per Shelf, Up to 600kg Total Weight Size: 1524 x 814 x 305mm	

• Heavy steel profile uprights • Removable shelves • Easy and quick erection • Available in Grey or White

TOOL CABINETS & WORKBENCHES

Heavy Duty Workbenches • Load Capacity: 1000kg • Drawer Loading Capacity: 100kg
 • Laminated Tops • Optional extra: Rack set **WQ-62** & **WQ-63**

	Work Bench Only	c/w 3 x Drawers	c/w 3 Drawer Cabinet
Code	WA-67A-1	WAT-6203A-1	WAS-64031A-1
Size (mm)	800H x 1800W x 750D	800H x 1800W x 750D	800H x 1800W x 750D

Standard Workbenches • Load Capacity: 600kg • Drawer Loading Capacity: 60kg each
 • Laminated Tops • Optional extra: Rack set **WQ-62** & **WQ-63**

	Perforated Rack Sets		c/w 2 x Drawers	c/w 4 Drawer Cabinet
Works with both heavy-duty and standard workbenches				
	Code	WQ-62	WQ-63	WBS-63021F
Size (mm)	605H x 1802W x 205D	605H x 1802W x 325D 25H x 1795W x 300D	800H x 1800W x 750D	800H x 1800W x 750D

TRESTLES & PORTABLE WORK BENCHES

	Height Adjustable Trestle	Portable Work Benches		
Code	HL4020-H	HL4020-C		RWM-WB002
Size (mm)	1055W x 475L x 800-920H	700W x 590L x 880H		605W x 630D x 780H
Carrying Capacity	350kg/Pair	200kg		-

TROLLEYS & MINI STEP LADDER

Trolleys	Trolley for moving appliances up to 100kg	Plastic Step-Ladder	NEW Foldable Cart
HL2031	HL5039	HL5040-D	ZYD-01
Service Cart Maximum load 30kg/level 715 x 465 x 250mm	Home Trolley (set of 2) Maximum load 100kg/set	Hand Trolley Maximum load 100kg 470 x 210 x 830(H)mm	Top Ø286mm Bottom Ø435mm Height 425mm Maximum load 300kg
			Open Size: 380 x 170 x 560 x 128mm Close Size: 560 x 380 x 100mm Single Loading: 240kg max Gross Weight: 8kg

STORAGE BINS

Hanger Bins – Material: Polypropylene

Code	TKI-8301	TKI-8302	TKI-8303	TKI-8304	TKI-8305
Size (mm)	50H x 105W x 110L	75H x 105W x 140L	75H x 105W x 190L	125H x 140W x 220L	125H x 140W x 270L
Colour	Red	Blue	Yellow	Blue	Red

• Each Bin supplied with index label • All of the above Bins are designed to assemble (interlock) onto the Louvred Hanger Board, see KH-306 below

Team Bins – Material: Polypropylene

Code	TKI-810	TKI-815	TKI-820	TKI-854	TKI-855
Size (mm)	75H x 100W x 160L	124H x 150W x 240L	155H x 200W x 340L	177H x 200W x 450L	177H x 300W x 450L
Colour	Yellow	Red	Blue	Blue	Blue

- Optional Extra: Back Link Clips Code: **EBTK0892**
- Each Bin supplied with index label and four supporting poles for interlocking Bins vertically
- Interlockable slots on either side ensure Bins are kept locked side by side

	Code	EBTK0892
		Back Link Clips per 100

Universal Team Bins – Material: • ABS Cabinet. • Polyethylene Drawers

Interlockable from left to right or top to bottom

Code	TKI-301	TKI-302	TKI-303	TKI-304
Cabinet Size (mm)	86H x 128W x 195D	86H x 128W x 195D	86H x 128W x 195D	86H x 128W x 195D
Drawers (included)	73H x 112W x 167D (1pcs)	35H x 116W x 167D (2pcs)	73H x 48W x 167D (2pcs)	35H x 53W x 167D (4pcs)

- Each Bin supplied with index label

Mobile Storage Bin Rack

c/w 64 small bins and 30 large bins.
Small bin: 75H x 105W x 165L
Large bin: 125H x 150W x 240L

HL3201

Size: 940 x 500 x 1250mm

Document Cabinets – Material: • 0.7mm cold Steel Plate Cabinet • Polyethylene Drawers

Code	A4G-345	TKI-2405	A4G-106	A4HG-10203	A4H-104
Cabinet Size (mm)	880H x 812W x 346D	310H x 460W x 230D	360H x 260W x 346D	360H x 260W x 346D	360H x 260W x 346D
Drawers (included)	45H x 230W x 326D (A4) (46pcs)	52H x 100W x 220D (20pcs)	45H x 230W x 326D (A4) (6pcs)	71H x 230W x 326D (A4) (2pcs) 45H x 230W x 326D (A4) (3pcs)	71H x 230W x 326D (A4) (4pcs)

Code	RM-530	B4HG-10203	B4H-104
Cabinet Size (mm)	880H x 900W x 420D Bins included 30 x TR-4116 (Bins) c/w 2 dividers per Bin Max dividers per Bin, 7	360H x 300W x 414D (mm) 71H x 270W x 393D (B4) (2pcs) 45H x 270W x 393D (B4) (3pcs)	360H x 300W x 414D (mm) 71H x 270W x 393D (B4) (4pcs)

Louvred Board – Material: • 0.7mm cold Steel Plate

Code	KH-306
Size (mm)	900W x 450H

- Anti-Slip Device
- Flexible Spacing
- Colour Labels (included)

NEW

ALUMINIUM LADDERS

Maximum Load 150kg



LS1108M

LS2108M

LS2206M

LJ503DR

LJG309DL

LS - Range:

- Compact design
- Faster operation
- Safety lock

LJ - Range:

- Strong mechanism
- Easy carry
- Light Weight

LJG - Range:

- Extra wide tread for comfort during extended use
- High top hand rail for additional stability
- Robust construction

Code	Description	Open/Extended Height
LJ503DR	3 Step Aluminium Ladder	1230mm
LJ506DR	6 Step Aluminium Ladder	1890mm
LS1108M	8 Step Aluminium Telescopic Ladder	2550mm
LS1112M	12 Step Aluminium Telescopic Ladder	3750mm
LS2108M	6 + 8 Step Double Telescopic Ladder	2520mm
LS2206M	2 x 6 Step Folding Telescopic Ladder	1850mm
LJG306DL	6-Wide step aluminium ladder with tool tray	1945mm
LJG309DL	9-Wide step aluminium ladder with tool tray	2644mm

NEW

UTILITY ROPES & CHAINS

Ropes



RMP-0615

RMP-1015H

RMP-420H

RCB-512

RPC-430

RS-55HP

Short Link Steel Chain



Code	Ø x Length	Type	Code	Ø x Length	Type	Code (30m)	Size Ø	Code (2m)	Size Ø
RMP-0615	6mm x 15m	Multipurpose	RPC-430	4mm x 30m	Para Cord	TOOC250	3mm	TOOC261	3mm
RMP-0823	8mm x 23m	Multipurpose	RS-55HP	5mm x 5m	Ski Rope	TOOC251	4mm	TOOC262	4mm
RMP-1030	10mm x 30m	Multipurpose	RS-510HP	5mm x 10m	Ski Rope	TOOC252	5mm	TOOC263	5mm
RMP-1215	12mm x 15m	Multipurpose	RS-530HP	5mm x 30m	Ski Rope	TOOC253	6mm	TOOC264	6mm
RMP-1015H	10mm x 15m	M/P on Reel	RS-710HP	7mm x 10m	Ski Rope	TOOC254	7mm	TOOC265	7mm
RMP-420H	4mm x 20m	M/P on Reel	RS-730HP	7mm x 30m	Ski Rope	TOOC255	8mm		
RMP-620H	6mm x 20m	M/P on Reel	RS-1015HP	10mm x 15m	Ski Rope	TOOC256	10mm		
RCB-512	5mm x 12m	Cotton Blend	RS-1030HP	10mm x 30m	Ski Rope				

• For Lifting Purposes • Steel-Wire Electro-Galvanised

NEW

TIE DOWN STRAPPING

	2pcs	2pcs	4pcs	12pcs
Code	RTD-25X5M/1P	RTD-25X5M/2P	RTD-25X5M/4P	TDK-12P
Strap size	25mm x 5m	25mm x 5m	25mm x 5m	2 x 25mm Tie Down Straps with buckle
Breaking Strain	500kg	500kg	500kg	2 x 2.5m x 25mm Tie Down Ratchet with Hook
Includes	1 x Ratchet Tie Down Strap with S Hooks	2 x Ratchet Tie Down Strap with S Hooks	2 x Ratchet Tie Down with Hooks + Tie Down Straps 2 Buckles	8 x 8mm Bungee Cords 400,600, 800,1000mm
	2pcs	2pcs	5pcs	Bungee Cords
Code	RTD-50x6M/1P	RTD-38X5M/2P	TDK-5P	BC-8X800/2P
Strap size	50mm x 6m	38mm x 5m	3.5m x 25mm Tie Down strap	8mm x 800mm
Breaking Strain	1300kg	2000kg	4 x 4.5mm Bungee Cords	BC-8X800/4P
Includes	1 x J Hooks	J Hook		8mm x 800mm
				BC-10X2000/2P
				10mm x 2000mm
				c/w 3.2mm Steel Hooks

Warranty on Generators: 1 Year / 1000 Hours, whichever comes first.

SINGLE PHASE PETROL GENERATORS - 230VAC



ATS-6.6KW-SP

ATS Available for selected models (to be ordered separately)



NPG12010E



GEN2800KW



GEN5500KW

Code	Petrol Open Frame		Single Phase Petrol	
	NPG6500E1	NPG12010E	GEN2800KW	GEN5500KW
Rated Output kVA/ kW	5.0 / 4.25	8.5 / 7.2	2.8	5.5
Rated Current (A)	21.7	37		
Starting	Electric+Recoil	Electric+Recoil	Recoil	Electric Recoil
12VDC O/P Rated Current	8.3A	8.3A		
Engine Type	Single Cylinder 4-Stroke Air Cooled	VTwin 4-Stroke Air Cooled	Single cylinder, 4-stroke, Forced air cooling	Single cylinder, 4-stroke, Forced air cooling, OHV
Fuel Tank	25ℓ	40ℓ	15L	6.5L
Displacement CC	389	688	163	389
Run Time ¾ Loading (Hrs)	10	9	13	3
Norm Run Speed (RPM)	3000			
Size L x W x H (mm)	700 x 525 x 560	910 x 650 x 846	610 x 470 x 450	720 x 550 x 530
Dry Weight	81kg	175kg	42	82
Noise Level (7m)	72dB	78dB	65	72
Standard Items	Fuel Gauge, Voltmeter, Circuit breaker, AVR, Battery (electric start only)		Automatic Regulator	Auto overload protection, AVR
ATS Code	ATS-6.6KW-SP		-	-
Wheels	Incl.		-	-

SINGLE PHASE DIESEL GENERATORS - 230VAC



NDG4000CLE



NDG9F



NDG17FS

Auto Transfer Switch



SKX2-80/4P

Code	Diesel Open Frame		Diesel Silent	
	NDG4000CLE	NDG9F	NDG3500SE	NDG17FS
Rated Output kVA/ kW	3.0 / 2.5	8.0 / 6.8	2.8 / 2.3	15.0 / 12.8
Rated Current (A)	13	34.8	12.2	65.2
Starting	Electric+Recoil	Electric	Electric	Electric
12VDC O/P Rated Current	8.3A	8.3A	8.3A	N/A
Engine Type	Single Cylinder 4-Stroke Air Cooled	3 Cylinder Water Cooled	Single Cylinder 4-Stroke Air Cooled	4 Cylinder 4-Stroke Water cooled
Fuel Tank	12.5ℓ	42ℓ	15ℓ	42ℓ
Displacement CC	306	1357	306	2545
Run Time ¾ Loading (Hrs)	9	10	12	10
Norm Run Speed (RPM)	3000	1500	3000	1500
Size L x W x H (mm)	710 x 475 x 650	1750 x 790 x 1070	950 x 550 x 743	1570 x 780 x 1050
Dry Weight	70kg	402kg	150kg	750kg
Noise Level (7m)	82dB	85dB	71dB	65dB
Standard Items	Fuel Gauge, Voltmeter, AC Circuit breaker, Battery (electric start only) Auto Decompression	HGM6120U Engine Controller	Fuel Gauge, Circuit Breaker, Battery, Digital Display (Voltage, Frequency, Timer & Oil Pressure	HGM6120U Engine Controller
Wheels	Incl.	Incl.	Incl.	No
Auto Transfer Switch	N/A		ATS-5KW-SD	SKX2-80/2P
ATS Features	Auto Transfer Switch Panel Includes: Manual/Auto Switch, LED indication for mains power, generator power, Engine On/Off. Only suitable for use with Navigator gensets. (To be ordered separately)			
Engine Controller Included	Smartgen HGM6120U: Intelligent Control & Monitoring of generator parameters, mains failure/restoration with output for control of optional auto transfer switch.			

THREE PHASE GENERATORS - 400VAC



ATS-5KW-SD-3P

ATS Available for selected models (to be ordered separately)



NPG6500TE

Code	Petrol Open Frame	
	NPG6500TE	
Rated Output kVA/ kW	6.25 / 5	
Rated Current (A)	9.1	
Starting	Electric+Recoil	
12VDC O/P Rated Current	8.3A	
Engine Type	Single Cylinder 4-Stroke	
Fuel Tank	25ℓ	
Displacement CC	389	
Run Time ¼ Loading (Hrs)	11.5	
Norm Run Speed (RPM)	3000	
Size L x W x H (mm)	720 x 485 x 630	
Dry Weight	85.6kg	
Noise Level (7m)	76dB	
Standard Items	Fuel Gauge, Voltmeter, Circuit Breaker, Battery (Electric Start Only)	
ATS Code	ATS-6.6KW-TP	
Wheels	Incl.	

THREE PHASE SILENT DIESEL GENERATORS - 400VAC

Auto Transfer Switch



NDG21FS3

Fitted with Intelligent Control Panel (ICP) & Auto Mains Failure (AMF) circuits. ATS: Mains Change Over Switchgear Panel to be ordered separately.

Code	Diesel Ultra Silent					
	NDG12FS3*	NDG21FS3*	NDG28FS3*	NDG33FS3*	NDG41FS3	NDG66FS3
Rated Output kVA/ kW	11 / 8.8	19 / 15	25 / 20	30 / 24	38 / 30	60 / 48
Rated Current (A)	15.9A	27.5	36.2	43.5	55.1	87
Starting	Electric	Electric	Electric	Electric	Electric	Electric
Engine Type	4 Cylinder 4-Stroke Water Cooled	3 Cylinder 4-Stroke Water Cooled	4 Cylinder 4-Stroke Water Cooled			
Fuel Tank	42ℓ	42ℓ	80ℓ	80ℓ	80ℓ	100ℓ
Displacement CC	1617	2545	2834	2856	4752	4214
Run Time ¼ Loading (Hrs)	10	10	10	10	10	10
Norm Run Speed (RPM)	1500	1500	1500	1500	1500	1500
Size L x W x H (mm)	1570x780x1050	1570x780x1050	1660x780x1050	1660x780x1050	1660x950x1050	1900x850x1100
Dry Weight	685kg	750kg	900kg	990kg	1200kg	1400kg
Noise Level (7m)	65dB	65dB	65dB	65dB	65dB	65dB
Auto Transfer Switch	SKX2-20/4P	SKX2-40/4P	SKX2-63/4P		-	
ATS Features	Auto Transfer Switch Panel Includes: Manual/Auto Switch, LED indication for mains power, generator power, Engine On/Off. Only suitable for use with Navigator gensets. (To be ordered separately)					
Engine Controller included	Smartgen HGM6120U: Intelligent Control & Monitoring of generator parameters, mains failure/restoration with output for control of optional auto transfer switch.					

TEST INSTRUMENTS, TOOLS & GENSETS

NEW

DIGITAL PETROL GENERATORS

Sine wave digital inverter generating sets

A new generation of sine wave inverter generating sets with micro processor control. After signal processing a high quality pure sine wave can be acquired with high frequency LC filtering. This type of generator has no waveform distortion offering pure sine wave power with high power factor for instant high loading capacity. A wide range of application areas can be readily assured such as household appliances, computers and communication equipment, medical equipment and other precision instruments. Easy carrying, low noise and "smart fuel saving" features make these generators ideal for household, outdoor and camping requirements.



Code	TOOI511	TOOI512	TOOI513
Rated Output kVA/kW	1.2kVA/1kW	2kVA/1.8kW	3.5kVA/3000W
Start	Recoil	Recoil	Recoil
DC Output	12V / 4A	12V / 4A	12V / 4A
Fuel Tank	3.6L	5.7L	5.7L
Fuel	Unleaded Petrol	Unleaded Petrol	Unleaded Petrol
Overload Protection	Yes	Yes	Yes
Approx. Run Time	4.3 Hours	4.6 Hours	4.6 Hours
Noise Level (7m)	58dB	60dB	63dB
Digital Display	No	No	No
Wheels	No	No	No

ECO-FRIENDLY OPEN FRAME (PETROL)



NECO2990E



Rear View



NECO3990E

ATS Available for selected models (to be ordered separately)











Features





- Engine designed to have low fuel consumption
- Advanced design of alternator and cooling system provide longer life at high temperatures
- Powerful heavy duty engines built to meet stringent European and US emission controls for generators
- Low noise due to new design of silencer made of Al coated steel producing <2dB less exhaust noise compared to normal exhaust system
- Easy starting with electric starter supplied with maintenance free battery
- Water proof control panel fitted with electromagnetic/pneumatic circuit breaker
- Airless flat free wheels

Code	230V Single Phase				400V 3 Phase
	NECO2990E	NECO3990E	NECO7990E	NECO8990E	NECO8990TE
Rated Output kVA/kW	2.0 / 1.7	2.6 / 2.3	5.0 / 4.2	6.0 / 5.5	7.5 / 6.3
Rated Current (A)	8.7	11.4	21.7	27.7	10.9
Starting	Recoil/Electric	Recoil/Electric	Recoil/Electric	Recoil/Electric	Recoil/Electric
12VDC O/P Rated Current	-	-	8.3	8.3	8.3
Engine Type	Single Cylinder, 4-Stroke, Air Cooled				
Fuel Tank	13ℓ	13ℓ	26ℓ	26ℓ	26ℓ
Displacement CC	163	196	389	439	439
Run Time ¾ Loading (Hrs)	11	10	9.5	8.5	8.5
Normal Running Speed (RPM)	3000				
Size LxWxH (mm)	597x465x488	597x465x488	945x594x680	945x594x681	945x594x681
Dry Weight	50kg	59kg	96kg	103kg	103kg
Noise Level (7M)	66dB	66dB	70dB	70dB	70dB
Standard Items	4-in-1 Digital monitor (hour meter, frequency, oil warning, voltage meter)				
Wheels	Yes				
ATS Code	-	-	-	SATS1P36/2P	SATS3P18/4P







CLEANING & DEGREASING FOR AUTOMOTIVE

	Brake Cleaner	Multi-Foam Cleaning	Adhesive Spray - Extra Strong	Workshop Cleaner
	- 500ml  	- 400ml  	- 500ml  	- 5 Litre  
Code	WS-BC	WS-MFC	WS-AS	WS-WC
	<p>A universal cleaner especially for automotive applications. In comparison with conventional thinners, WEICON Brake Cleaner evaporates without residue. It quickly degreases and cleans metals, glass and many plastics without a problem.</p> <p>Applications</p> <ul style="list-style-type: none"> • Removal of dirt and residue containing oil and grease • On brakes (drum and disk brakes, brake linings, brake shoes, cylinders, springs and bushings) • On clutches (clutch linings and clutch parts) • On engine parts (carburetors, petrol and oil pumps, gears, etc.) 	<p>A universally applicable, powerful foam cleaner. WEICON Multi-Foam is environmentally sound, bio-degradable, free of phosphate, formaldehyde as well as corrosive and caustic additives</p> <p>Applications</p> <ul style="list-style-type: none"> • Cleans all glass, metal & plastic parts without leaving residue • Thoroughly eliminates insects, smears and protective films • Gently removes stains from rugs and upholstery • Cleans and cares for all plastic and lacquered surfaces on boats, motorcycle casings and bicycles • Dissolves dirty layers from fittings and tiles 	<p>Special type for permanent and strong bonding of rough and uneven surfaces. A special valve allows small, medium or large adhesive quantities to be sprayed.</p> <p>Applications</p> <p>For bonding big surfaces of</p> <ul style="list-style-type: none"> • Felt, PVC foil, imitation leather, carpets • Plastics and paper • Foam and sponge rubber • Insulating material, flexible foam plastics • Vinyl, leather, rubber, metal and wood 	<p>Cleans and degreases all materials, plastics, types of rubber, glass, ceramics and wood. It removes grease, oil, resin, rust, wax, nicotine, insect dirt, bitumen and tar specs.</p> <p>Applications</p> <ul style="list-style-type: none"> • Machines - all kinds of tools • Work shop facilities, e.g. work benches, shelves, sliding doors, industrial flooring • Motor vehicles, e.g. forklift, trucks, pallet trucks, indoor transporters • Motor parts, e.g. oil sumps, valve covers, starters, generators

LUBRICATING & MULTIFUNCTIONAL OILS

	W44T Turbo-Power Spray	Silicone Spray	AT-44 Allround Spray	Rust-Shock
	- 400ml 	- 400ml 	- 400ml 	- 400ml 
Code	WS-W44	WS-SS	WS-AT44	WS-RS
	<p>W44T covers a wide range of industrial and maintenance applications. Due to its special formula and excellent creep properties, corrosion protection, water-resistance, lubrication, preservation and cleaning are combined in one product. W44T offers good protection against atmospheric influences. For this reason, it is used almost unlimitedly in the areas of workshops, automobiles, shipping, electrical systems, agriculture, household and hobbies.</p>	<p>Silicone Spray is an ideal lubricant and separating agent for rational production and servicing. At the same time, it assumes the function of a preservative and care product for plastic, rubber and metal.</p>	<p>AT-44 Allround Spray with PTFE is used in all industrial and workshop areas. Due to its special formula and its very low coefficient of friction resulting from the high percentage of PTFE, corrosion protection, cleaning, water-resistance, lubrication, and conservation are combined in one product.</p>	<p>Rust-Shock, the "chemical screwdriver" loosens all kinds of rusted screw connections: it works within seconds due to its two-fold function:</p> <ul style="list-style-type: none"> • The special composition of the materials generates a "chill effect" on the corroded workpiece. Rust-Shock deeply penetrates into these small spaces created by this cold shrinking process due to its high capillary effect. • There, it loosens the rust crystals in seconds and thus neutralises the connection between the rust layers.

ELASTIC ONE-COMPONENT ADHESIVES & SEALANTS

	Flex 310 M Classic - 310ml	Flex 310 M Super-Tack - 290ml	Aqua-Flex - 310ml
Code	WST-310CL-*	WST-310SUP	WST-AF-*
	 <p>Suitable for universal use. WEICON Flex 310 M Classic adhesive and sealant is strong, overpaintable (wet in wet), sandable, has outstanding aging stability and good resistance to UV rays. It is resistant to freshwater and salt water and is free of silicone, isocyanate, halogens or solvents. Can be used as an adhesive in food technology. Suitable for the bonding of metals, many plastics, ceramic, wood, glass and stone.</p> <p>*Add colour to code: WH (White), BK (Black), G (Grey)</p>	 <p>High initial strength. WEICON Flex 310 M Super-Tack adhesive and sealant is very strong, non-corrosive, overpaintable (wet in wet), sandable, weather resistant, resistant to UV rays and is free of silicone, isocyanate, halogens or solvents. Very high initial bonding power and the fast development of adhesive strength enable bonds to be achieved even on vertical surfaces. Suitable for the bonding of metals, many plastics, ceramics, wood, glass and stone.</p>	 <p>Ideal for wet and moist surfaces. WEICON Aqua-Flex adhesive & sealant is strong, has outstanding ageing stability, & is resistant to weathering, UV rays, freshwater and salt water. It is free of silicone, isocyanate, halogens or solvents. Can be used as an adhesive in foodstuff technology. Suitable for the bonding of numerous materials such as metal, plastic, ceramics, wood, glass and stone.</p> <p>*Add colour to code: WH (White), BK (Black), G (Grey)</p>
	Solarflex - 290ml	Flex 310M Crystal - 310ml	Blackseal
Code	WST-310SOL-WH	WST-310CRYSTAL	WST-BLS-*
	 <p>Developed for solar industry. WEICON Solar-Flex® is strong, non-corrosive, overpaintable (wet in wet), weather resistant and resistant to UV rays. It is free of silicone, isocyanate, halogens and solvents. Both the very high initial bonding power and the fast development of adhesive strength enable bonds to be achieved even on vertical surfaces.</p>	 <p>Crystal-clear curing. WEICON Flex 310 M Crystal adhesive and sealant is transparent, strong, overpaintable (wet in wet), sandable, has outstanding aging stability and good resistance to UV rays. It contains no silicone, isocyanate, halogens or solvents. Can be used as an adhesive in food technology. suitable for the bonding of glass, PC, PMMA and acrylic glass, metals, many plastics, ceramics, wood and stone.</p>	 <p>Extremely resistant against oil and grease. WEICON Black-Seal adhesive and sealant is black, high-temperature resistant (+280°C), free of solvents, strong, oil resistant, grease resistant, pressure resistant, resistant to ageing and extremely elastic. Suitable for bonding and sealing in applications where particularly high oil and grease resistance is required.</p> <p>*Add Tube size to code: 85 - 85ml 200 - 200ml 310 - 310ml</p>

Flex + Bond - 85ml



Code	WST-FB-*
	<p>Highly elastic and strong. WEICON Flex+bond is strong, permanently elastic, temperature resistant from -40°C to +90°C (-40°F to +194°F), weather resistant, resistant to UV rays, overpaintable (wet in wet), sandable, and resistant to ageing and salt water. It is free of silicone, isocyanate, halogens and solvents. Can be used as an adhesive in foodstuff technology, as well as bonding nearly all materials to themselves and among each other such as metal, wood, plastic, glass, and ceramics.</p> <p>*Add Colour to code: WH (White), BK (Black), GR (Grey), CL (Clear) DISPLAY - Counter display for 20 Tubes</p>

Contact Adhesive



Code	WST-GMK2410-*
	<p>Permanently elastic and resistant to humidity GMK 2410 is an adhesive based on polychloroprene (CR) for the high-strength, full-surface and flexible bonding of rubber to rubber and rubber to metal. Also bonds cellular rubber (e. g. neoprene), leather, felt, insulating material, textiles, wood, and many plastics.</p> <p>*Add to code: 185 (185g tube), 300 (300g can)</p>

WITH MORE THAN
85,000
ELECTRICAL PRODUCTS

YOUR OPTIONS
ARE ENDLESS



DISTRIBUTED BY:

AC/DC SFC TOOLS



6th Edition March 2019

Specifications are subject to change from time to time,
without notification in this publication

© ACDC Dynamics CC 2018

HEAD OFFICE - JOHANNESBURG

P.O. Box 3812, Edenvale,
1610, South Africa
26 Nguni Drive
Longmeadow Estate West
Edenvale, Gauteng
South Africa

info@acdc.co.za

Reception 010 202 3300

Sales 010 202 3400

Technical 010 202 3500

Fax 010 202 3365

www.acdc.co.za

BRANCH CONTACT DETAILS

Johannesburg	010 202 3300
Germiston	011 418 9600
Cape Town	021 510 0710
Pinetown	031 700 4215
Riverhorse	031 492 4800

www.acdc.co.za

Distributors & Franchises throughout Southern Africa

© ACDC Dynamics CC 2018

THINK ELECTRICAL